





***Allen-Bradley***

***8 Input RTD  
Module***

***(Cat. No. 1794-IR8)***

# **User Manual**

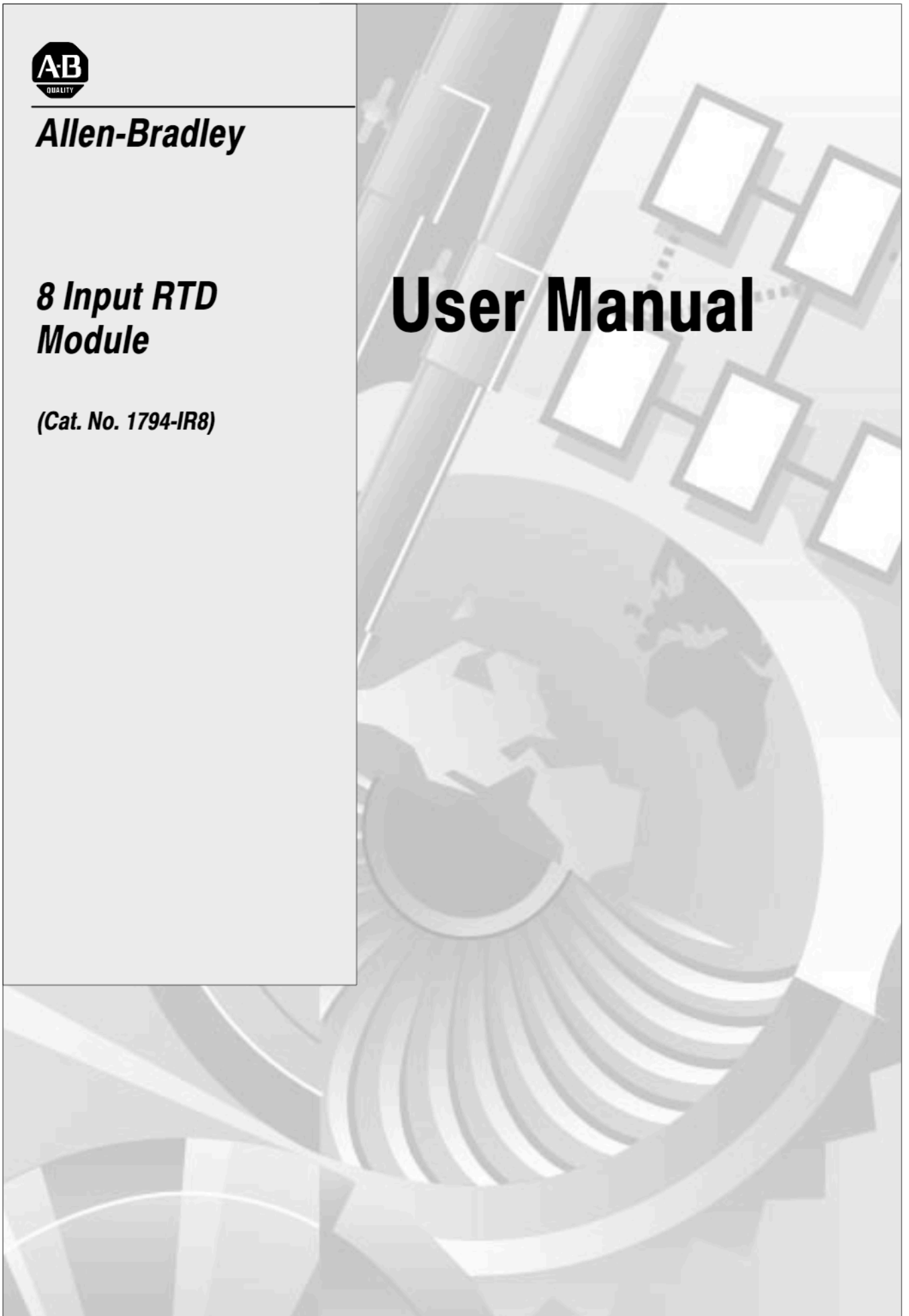

## Important User Information

Because of the variety of uses for the products described in this publication, those responsible for the application and use of this control equipment must satisfy themselves that all necessary steps have been taken to assure that each application and use meets all performance and safety requirements, including any applicable laws, regulations, codes and standards.

The illustrations, charts, sample programs and layout examples shown in this guide are intended solely for example. Since there are many variables and requirements associated with any particular installation, Allen-Bradley does not assume responsibility or liability (to include intellectual property liability) for actual use based upon the examples shown in this publication.

Allen-Bradley publication SGI-1.1, "Safety Guidelines For The Application, Installation and Maintenance of Solid State Control" (available from your local Allen-Bradley office) describes some important differences between solid-state equipment and electromechanical devices which should be taken into consideration when applying products such as those described in this publication.

Reproduction of the contents of this copyrighted publication, in whole or in part, without written permission of Allen-Bradley Company, Inc. is prohibited.

Throughout this manual we make notes to alert you to possible injury to people or damage to equipment under specific circumstances.



**ATTENTION:** Identifies information about practices or circumstances that can lead to personal injury or death, property damage, or economic loss.

---

Attention helps you:

- identify a hazard
- avoid the hazard
- recognize the consequences

**Important:** Identifies information that is especially important for successful application and understanding of the product.

**Important:** We recommend you frequently backup your application programs on appropriate storage medium to avoid possible data loss.

DeviceNet, DeviceNetManager, and RediSTATION are trademarks of Allen-Bradley Company, Inc.

PLC, PLC-2, PLC-3, and PLC-5 are registered trademarks of Allen-Bradley Company, Inc.

Windows is a trademark of Microsoft.

Microsoft is a registered trademark of Microsoft

IBM is a registered trademark of International Business Machines, Incorporated.

All other brand and product names are trademarks or registered trademarks of their respective companies.

# Table of Contents

---

<b>Using This Manual</b> .....	<b><a href="#">P-1</a></b>
Preface Objectives .....	<a href="#">P-1</a>
Audience .....	<a href="#">P-1</a>
Vocabulary .....	<a href="#">P-1</a>
What This Manual Contains .....	<a href="#">P-1</a>
Conventions .....	<a href="#">P-2</a>
For Additional Information .....	<a href="#">P-2</a>
Summary .....	<a href="#">P-2</a>
<b>Overview of FLEX I/O and your RTD Module</b> .....	<b><a href="#">1-1</a></b>
Chapter Objectives .....	<a href="#">1-1</a>
The FLEX I/O System .....	<a href="#">1-1</a>
How FLEX I/O RTD Modules Communicate with Programmable Controllers .....	<a href="#">1-1</a>
Typical Communication Between an Adapter and a Module .....	<a href="#">1-2</a>
Features of your Modules .....	<a href="#">1-3</a>
Chapter Summary .....	<a href="#">1-3</a>
<b>How to Install Your RTD Input Module</b> .....	<b><a href="#">2-1</a></b>
Before You Install Your Input Module .....	<a href="#">2-1</a>
European Union Directive Compliance .....	<a href="#">2-1</a>
EMC Directive .....	<a href="#">2-1</a>
Low Voltage Directive .....	<a href="#">2-2</a>
Power Requirements .....	<a href="#">2-2</a>
Wiring the Terminal Base Units (1794-TB2 and -TB3 shown) .....	<a href="#">2-3</a>
Installing the Module .....	<a href="#">2-4</a>
Connecting Wiring for the RTD Module .....	<a href="#">2-5</a>
Table 2.A	
Wiring connections for the 1794-IR8 RTD Input Module .....	<a href="#">2-6</a>
Example of 2-, 3- and 4-wire RTD Wiring to a 1794-TB3 Terminal Base Unit .....	<a href="#">2-7</a>
Example of 2-, 3- and 4-wire RTD Wiring to a 1794-TB3T Terminal Base Unit .....	<a href="#">2-7</a>
Module Indicators .....	<a href="#">2-8</a>
Chapter Summary .....	<a href="#">2-8</a>

<b>Module Programming</b> .....	<b><a href="#">3-1</a></b>
Chapter Objectives .....	<a href="#">3-1</a>
Block Transfer Programming .....	<a href="#">3-1</a>
Sample programs for Flex I/O Analog Modules .....	<a href="#">3-2</a>
PLC-3 Programming .....	<a href="#">3-2</a>
Figure 3.1	
PLC-3 Family Sample Program Structure .....	<a href="#">3-2</a>
PLC-5 Programming .....	<a href="#">3-3</a>
Figure 3.2	
PLC-5 Family Sample Program Structure .....	<a href="#">3-3</a>
PLC-2 Programming .....	<a href="#">3-3</a>
Chapter Summary .....	<a href="#">3-3</a>
<b>Writing Configuration to and Reading Status from Your Module with a Remote I/O Adapter</b> .....	<b><a href="#">4-1</a></b>
Chapter Objectives .....	<a href="#">4-1</a>
Configuring Your RTD Module .....	<a href="#">4-1</a>
Range Selection .....	<a href="#">4-2</a>
Input Scaling .....	<a href="#">4-2</a>
Enhanced Mode .....	<a href="#">4-3</a>
Hardware First Notch Filter .....	<a href="#">4-4</a>
Throughput in Normal Mode .....	<a href="#">4-4</a>
Throughput in Enhanced Mode .....	<a href="#">4-4</a>
Reading Data From Your Module .....	<a href="#">4-4</a>
Mapping Data for the Analog Modules .....	<a href="#">4-5</a>
RTD Input Module (1794-IR8) Image Table Mapping .....	<a href="#">4-5</a>
RTD Analog Input Module (1794-IR8) Read Words .....	<a href="#">4-5</a>
RTD Analog Input Module (1794-IR8) Write Words .....	<a href="#">4-6</a>
Word/Bit Descriptions for the 1794-IR8 RTD Analog Input Module .....	<a href="#">4-6</a>
Chapter Summary .....	<a href="#">4-8</a>
<b>How Communication Takes Place and I/O Image Table Mapping with the DeviceNet Adapter</b> .....	<b><a href="#">5-1</a></b>
Chapter Objectives .....	<a href="#">5-1</a>
About DeviceNetManager Software .....	<a href="#">5-1</a>
Polled I/O Structure .....	<a href="#">5-1</a>
Adapter Input Status Word .....	<a href="#">5-2</a>
System Throughput .....	<a href="#">5-3</a>
Mapping Data into the Image Table .....	<a href="#">5-3</a>
RTD Input Analog Module (1794-IR8) Image Table Mapping .....	<a href="#">5-3</a>
Memory Map of RTD Analog Input Module	
Image Table – 1794-IR8 .....	<a href="#">5-4</a>
Word/Bit Descriptions for the 1794-IR8 RTD Analog	
Input Module .....	<a href="#">5-4</a>
Defaults .....	<a href="#">5-7</a>

---

<b>Calibrating Your Module</b> .....	<b><u><a href="#">6-1</a></u></b>
Chapter Objective .....	<u><a href="#">6-1</a></u>
When and How to Calibrate Your RTD Module .....	<u><a href="#">6-1</a></u>
Tools and Equipment .....	<u><a href="#">6-1</a></u>
Manually Calibrating your RTD Input Module .....	<u><a href="#">6-2</a></u>
Flow Chart for Calibration Procedure .....	<u><a href="#">6-3</a></u>
Calibration Setups .....	<u><a href="#">6-4</a></u>
Wiring Connections for the RTD Module .....	<u><a href="#">6-4</a></u>
Read/Write Words for Calibration .....	<u><a href="#">6-4</a></u>
Offset Calibration .....	<u><a href="#">6-5</a></u>
Gain Calibration .....	<u><a href="#">6-6</a></u>
Table 6.A Calibration Resistance/Voltage Values for the 1794-IR8 .	<u><a href="#">6-6</a></u>
Calibrating Your RTD Module using DeviceNet Manager	
Software (Cat. No. 1787-MGR) .....	<u><a href="#">6-7</a></u>
Offset Calibration .....	<u><a href="#">6-7</a></u>
Gain Calibration .....	<u><a href="#">6-10</a></u>
<b>Specifications</b> .....	<b><u><a href="#">A-1</a></u></b>
RTD Accuracy at Worst Case .....	<u><a href="#">A-3</a></u>
Derating Curve .....	<u><a href="#">A-3</a></u>
Support Services .....	<u><a href="#">6-1</a></u>
Technical Support .....	<u><a href="#">6-1</a></u>
Engineering and Field Services .....	<u><a href="#">6-1</a></u>
Technical Training .....	<u><a href="#">6-1</a></u>
Repair and Exchange Services .....	<u><a href="#">6-1</a></u>

## Using This Manual

### Preface Objectives

Read this preface to familiarize yourself with this manual and to learn how to use it properly and efficiently.

### Audience

We assume that you have previously used an Allen-Bradley programmable controller, that you are familiar with its features, and that you are familiar with the terminology we use. If not, read the user manual for your processor before reading this manual.

In addition, if using this module in a DeviceNet system, you must be familiar with:

- DeviceNetManager™ Software, cat. no. 1787-MGR
- Microsoft Windows™

### Vocabulary

In this manual, we refer to:

- the individual RTD module as the “module.”
- the programmable controller as the “controller” or the “processor.”



### What This Manual Contains

The contents of this manual are as follows:

Chapter	Title	What's Covered
1	Overview of Flex I/O and Your RTD Module	Describes features, capabilities, and hardware components
2	How to Install Your RTD Input Module	Installation and connecting wiring
3	Module Programming	Block transfer programming and programming examples
4	Writing Configuration to and Reading Status from Your Module with a Remote I/O Adapter	Describes block transfer write and block transfer read configurations, including complete bit/word descriptions
5	How Communication Takes Place and I/O Image Table Mapping with the DeviceNet Adapter	Describes communication over the I/O backplane between the module and the adapter, and how data is mapped into the image table
6	Calibrating Your Module	Lists the tools needed, and the methods used to calibrate the RTD input module
<b>Appendix</b>		
A	Specifications	Module specifications, accuracy and derating curve

## Conventions

We use these conventions in this manual:

In this manual, we show:	Like this:
that there is more information about a topic in another chapter in this manual	
that there is more information about the topic in another manual	

## For Additional Information

For additional information on FLEX I/O systems and modules, refer to the following documents:

Catalog Number	Description	Publications	
		Installation Instructions	User Manual
1787-MGR	DeviceNetManager Software User Manual		1787-6.5.3
	Industrial Automation Wiring and Grounding Guidelines for Noise Immunity	1770-4.1	
1794	1794 FLEX I/O Product Data	1794-2.1	
1794-ADN	DeviceNet Adapter	1794-5.14	1794-6.5.5
1794-ASB	Remote I/O Adapter	1794-5.11	1794-6.5.3

## Summary

This preface gave you information on how to use this manual efficiently. The next chapter introduces you to the RTD module.

## Overview of FLEX I/O and your RTD Module

### Chapter Objectives

In this chapter, we tell you about:

- what the FLEX I/O system is and what it contains
- how FLEX I/O modules communicate with programmable controllers
- the features of your RTD module

### The FLEX I/O System

FLEX I/O is a small, modular I/O system for distributed applications that performs all of the functions of rack-based I/O. The FLEX I/O system contains the following components shown below:

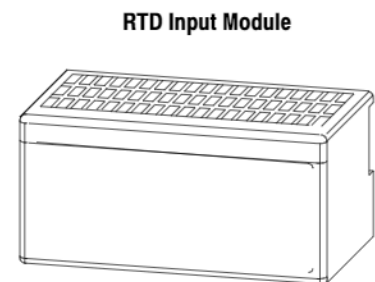
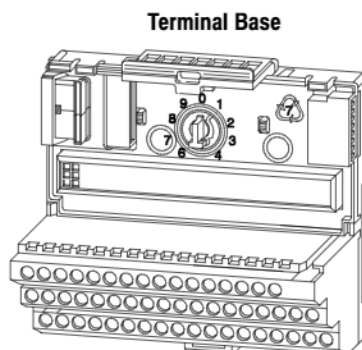
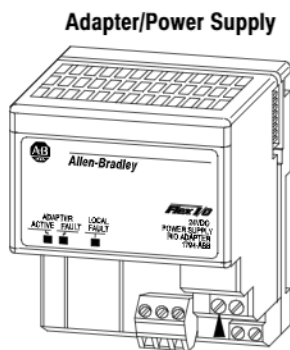

20125

- adapter/power supply – powers the internal logic for as many as eight I/O modules
- terminal base – contains a terminal strip to terminate wiring for two- or three-wire devices
- I/O module – contains the bus interface and circuitry needed to perform specific functions related to your application

### How FLEX I/O RTD Modules Communicate with Programmable Controllers

FLEX I/O RTD modules are block transfer modules that interface analog signals with any Allen-Bradley programmable controllers that have block transfer capability. Block transfer programming moves input or output data words between the module's memory and a designated area in the processor data table. Block transfer programming also moves configuration words from the processor data table to module memory.

The adapter/power supply transfers data to the module (block transfer write) and from the module (block transfer read) using BTW and BTR instructions in your ladder diagram program. These instructions let:

- the adapter obtain input or output values and status from the module
- you establish the module's mode of operation.

The illustration describes the communication process.

### Typical Communication Between an Adapter and a Module

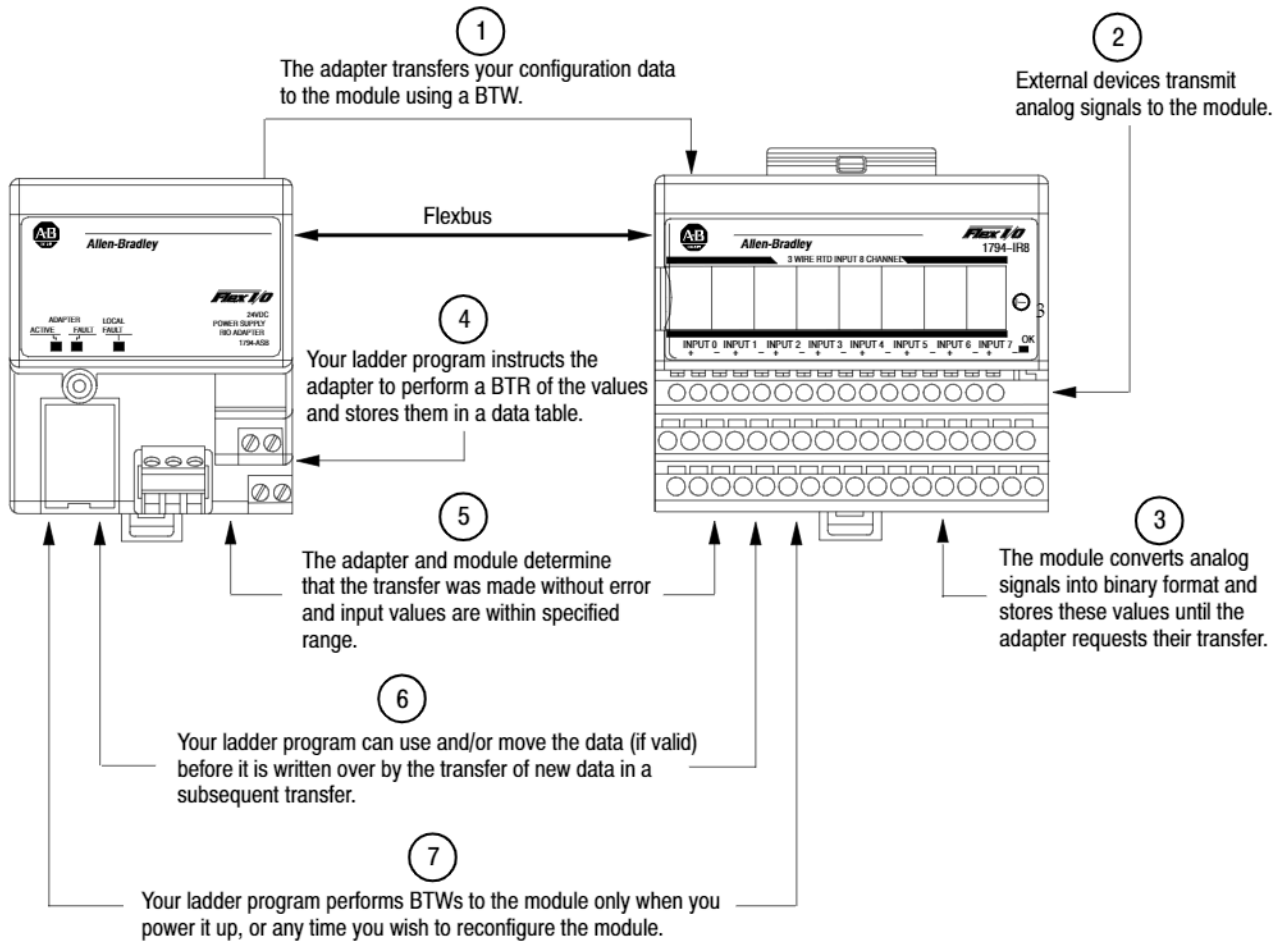

## Features of your Modules

The module label identifies the keyswitch position, wiring and module type. A removable label provides space for writing individual designations per your application. An indicator is provided to show when power is applied to the module.

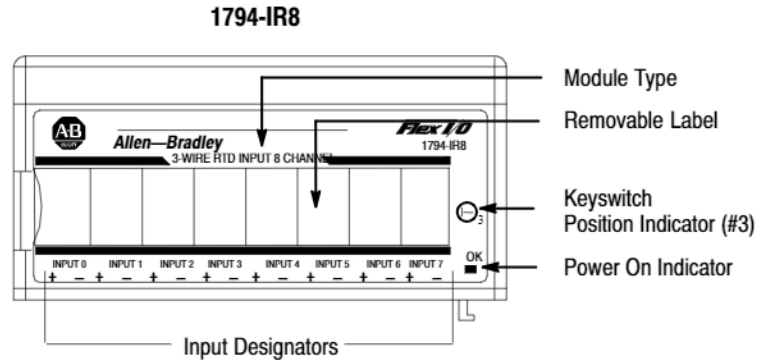

## Chapter Summary

In this chapter, we told you about the FLEX I/O system and the RTD module, and how they communicate with programmable controllers.

## How to Install Your RTD Input Module

In this chapter, we tell you:

- how to install your module
- how to set the module keyswitch
- how to wire the terminal base
- about the indicators

### Before You Install Your Input Module

Before installing your analog module in the I/O chassis:

You need to:	As described under:
Calculate the power requirements of all modules in each chassis.	Power Requirements, page <a href="#">2-2</a>
Position the keyswitch on the terminal base	Installing the Module, page <a href="#">2-4</a>



**ATTENTION:** The RTD module does not receive power from the backplane. +24V dc power must be applied to your module before installation. If power is not applied, the module position will appear to the adapter as an empty slot in your chassis.

### European Union Directive Compliance

If this product has the CE mark it is approved for installation within the European Union and EEA regions. It has been designed and tested to meet the following directives.

#### EMC Directive

This product is tested to meet Council Directive 89/336/EEC Electromagnetic Compatibility (EMC) and the following standards, in whole or in part, documented in a technical construction file:

- EN 50081-2EMC – Generic Emission Standard, Part 2 – Industrial Environment
- EN 50082-2EMC – Generic Immunity Standard, Part 2 – Industrial Environment

This product is intended for use in an industrial environment.

### Low Voltage Directive

This product is tested to meet Council Directive 73/23/EEC Low Voltage, by applying the safety requirements of EN 61131-2 Programmable Controllers, Part 2 – Equipment Requirements and Tests.

For specific information required by EN 61131-2, see the appropriate sections in this publication, as well as the following Allen-Bradley publications:

- Industrial Automation Wiring and Grounding Guidelines For Noise Immunity, publication 1770-4.1
- Guidelines for Handling Lithium Batteries, publication AG-5.4
- Automation Systems Catalog, publication B111

### Power Requirements

The wiring of the terminal base unit is determined by the current draw through the terminal base. Make certain that the current draw does not exceed 10A.



**ATTENTION:** Total current draw through the terminal base unit is limited to 10A. Separate power connections may be necessary.

---

Methods of wiring the terminal base units are shown in the illustration below.

**Wiring the Terminal Base Units (1794-TB2 and -TB3 shown)**



**ATTENTION:** Do not daisy chain power or ground from the RTD terminal base unit to any ac or dc discrete module terminal base unit.

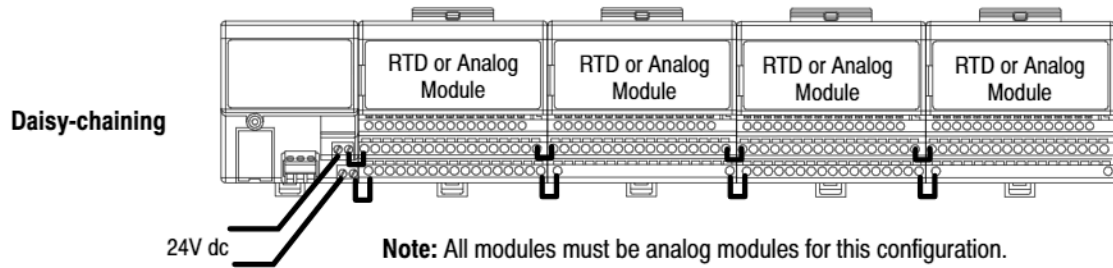

**Wiring when total current draw is less than 10A**

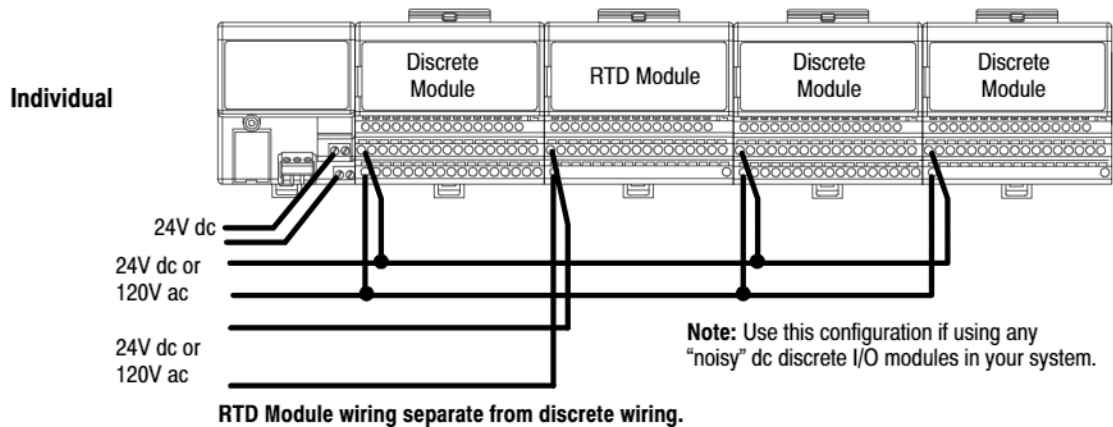

**Wiring when total current draw is greater than 10A**

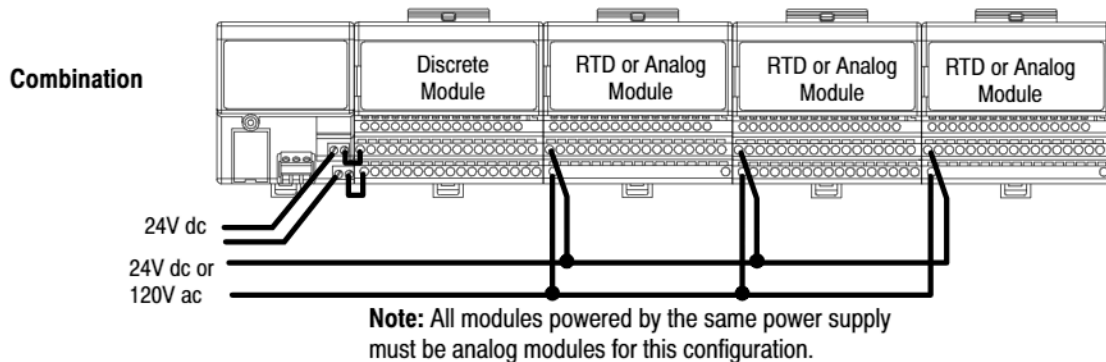

**Total current draw through any base unit must not be greater than 10A**

## Installing the Module

The RTD analog module mounts on a 1794-TB2, -TB3 or TB3T terminal base unit.

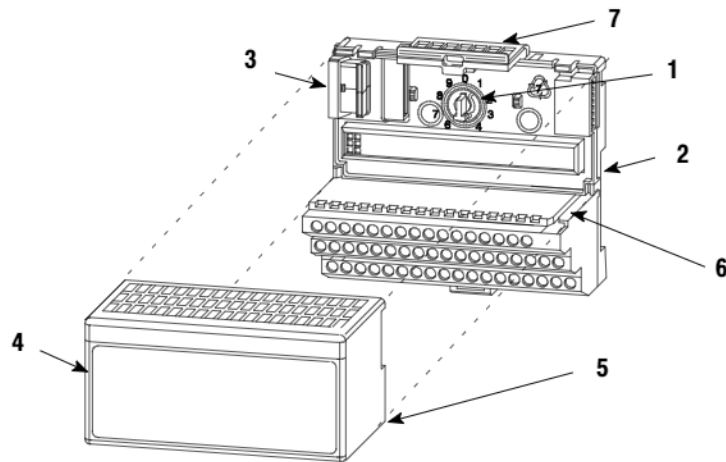

1. Rotate the keyswitch (1) on the terminal base unit (2) clockwise to position 3.
2. Make certain the flexbus connector (3) is pushed all the way to the left to connect with the neighboring terminal base/adaptor. **You cannot install the module unless the connector is fully extended.**



**ATTENTION:** Remove field-side power before removing or inserting the module. This module is designed so **you can remove and insert it under backplane power**. When you remove or insert a module with field-side power applied, an electrical arc may occur. An electrical arc can cause personal injury or property damage by:

- sending an erroneous signal to your system's field devices causing unintended machine motion
- causing an explosion in a hazardous environment

Repeated electrical arcing causes excessive wear to contacts on both the module and its mating connector. Worn contacts may create electrical resistance.

3. Before installing the module, check to make sure that the pins on the bottom of the module are straight so they will align properly with the female connector in the terminal base unit.
4. Position the module (4) with its alignment bar (5) aligned with the groove (6) on the terminal base.
5. Press firmly and evenly to seat the module in the terminal base unit. The module is seated when the latching mechanism (7) is locked into the module.
6. Repeat the above steps to install the next module in its terminal base unit.

## Connecting Wiring for the RTD Module

Wiring to the RTD module is made through the terminal base unit on which the module mounts.

Compatible terminal base unit are:

Module	1794-TB2	1794-TB3	1794-TB3T <sup>1</sup>
1794-IR8	Yes	Yes	Yes

<sup>1</sup> The 1794-TB3T terminal base unit contains cold junction compensation for use with thermocouple modules.

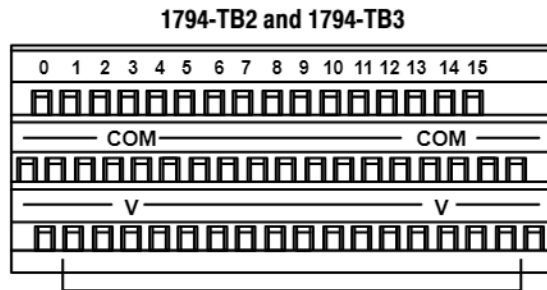

V = 24V dc  
COM = 24V dc common  
These terminals on 1794-TB3 only.

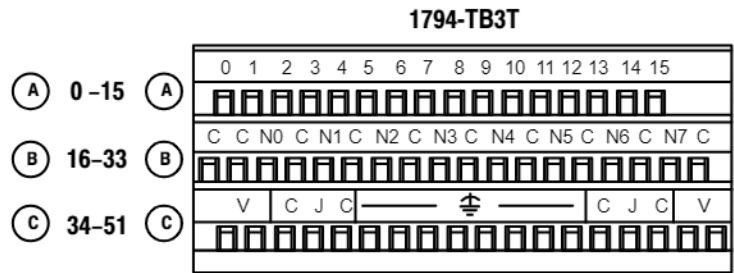

Where: V = 24V dc  
C = 24V dc common  
CJC = cold junction compensation  
N = additional input  
⏏ = chassis ground

### Connecting Wiring using a 1794-TB2, -TB3 and -TB3T Terminal Base Units

1. Connect the individual signal wiring to numbered terminals on the **0–15** row (**A**) on the terminal base unit. Connect the high side to the even numbered terminals, and the low side to the odd numbered terminals. See Table 2.A.
2. Connect channel common to the associated signal return terminal on row **B**, as shown in Table 2.A.
3. Terminate shields:
  - On 1794-TB2 and -TB3 bases only: terminate shields to the associated shield return terminals on row (**B**).
  - On 1794-TB3T bases only: terminate shields to terminals 39 to 46 on row **C**.

**Important:** 1794-TB2 and -TB3 terminal base units have row (B) bussed together. When you terminate your shields to this row, the shields will be at the same potential as the power supply return.

4. Connect +24V dc to terminal 34 on the **34–51** row (**C**), and 24V common to terminal 16 on the **B** row.

**Important:** To reduce susceptibility to noise, power analog modules and discrete modules from separate power supplies.

5. If daisy chaining the +24V dc power to the next base unit, connect a jumper from terminal 51 on this base unit to terminal 34 on the next base unit.



**ATTENTION:** Do not daisy chain power or ground from the RTD terminal base unit to any ac or dc discrete module terminal base unit.



**ATTENTION:** The RTD modules do not receive power from the backplane. +24V dc power must be applied to your module before operation. If power is not applied, the module position will appear to the adapter as an empty slot in your chassis. If the adapter does not recognize your module after installation is completed, cycle power to the adapter.

**Table 2.A Wiring connections for the 1794-IR8 RTD Input Module**

RTD Channel	1794-TB2 and -TB3 Terminal Base Units				1794-TB3T Terminal Base Unit			
	High Signal Terminal	Low Signal Terminal	Signal Return <sup>1</sup>	Shield Return	High Signal Terminal	Low Signal Terminal	Signal Return <sup>1</sup>	Shield Return <sup>2</sup>
0	0	1	17	18	0	1	17	39
1	2	3	19	20	2	3	19	40
2	4	5	21	22	4	5	21	41
3	6	7	23	24	6	7	23	42
4	8	9	25	26	8	9	25	43
5	10	11	27	28	10	11	27	44
6	12	13	29	30	12	13	29	45
7	14	15	31	32	14	15	31	46
24V dc Common	16 thru 33				16, 17, 19, 21, 23, 25, 27, 29, 31 and 33			
+24V dc power	1794-TB2 - 34 and 51 1794-TB3 - 34 thru 51				34, 35, 50 and 51			
<sup>1</sup> When using a 2-wire RTD, jumper the signal return to the low signal terminal.					<sup>2</sup> Terminals 39 to 46 are chassis ground.			



**ATTENTION:** Total current draw through the terminal base unit is limited to 10A. Separate power connections to the terminal base unit may be necessary.

### Example of 2-, 3- and 4-wire RTD Wiring to a 1794-TB3 Terminal Base Unit

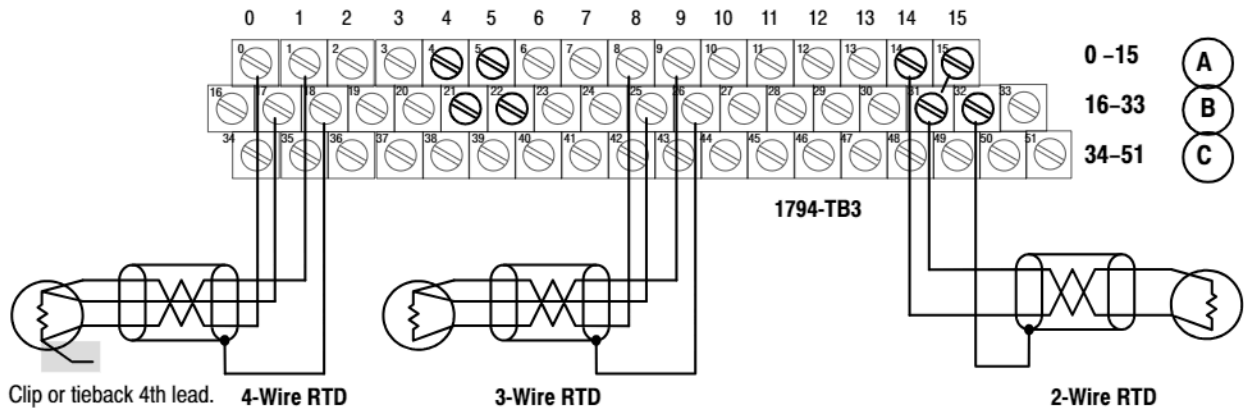

### Example of 2-, 3- and 4-wire RTD Wiring to a 1794-TB3T Terminal Base Unit

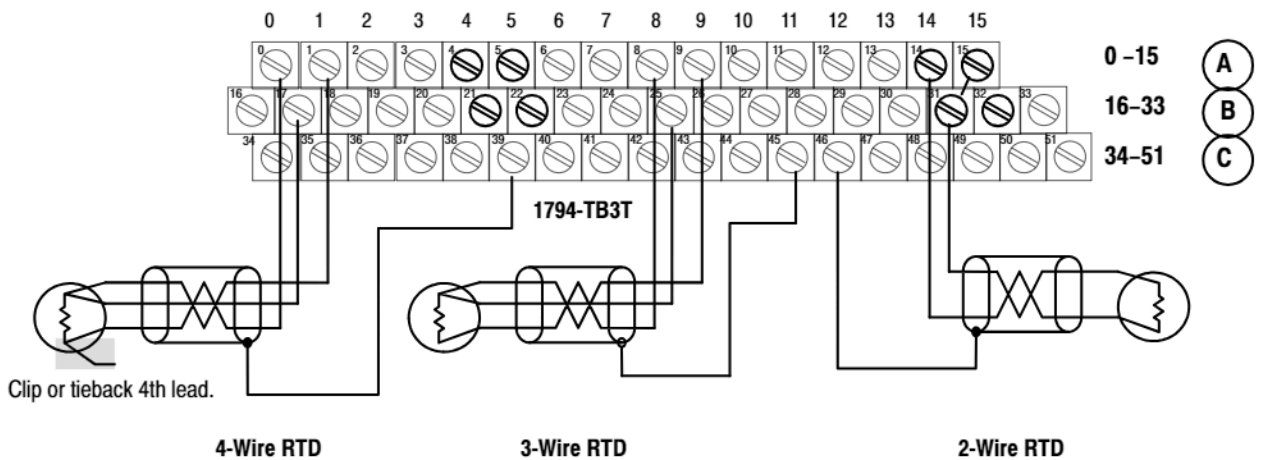

## Module Indicators

The RTD module has one status indicator that is on when power is applied to the module. This indicator has 3 different states:

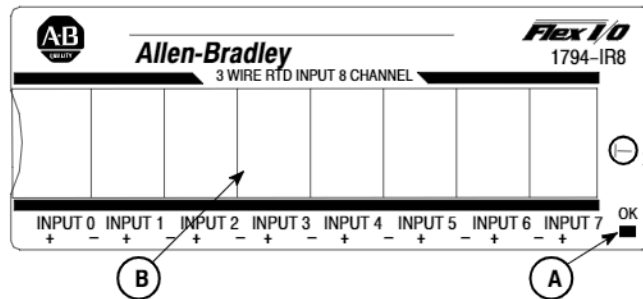

**A** = Status Indicator - indicates diagnostic results and configuration status

**B** = Insertable label for writing individual input designations

Color	State	Meaning
Red	On	Indicates a critical fault (diagnostic failure, etc.)
	Blinking	Indicates a noncritical fault (such as open sensor, input out of range, etc.)
Green	On	Module is configured and fully operational
	Blinking	Module is functional but not configured
	Off	Module not powered

## Chapter Summary

In this chapter, we told you how to install your input module in an existing programmable controller system and how to wire to the terminal base units.

## Module Programming

### Chapter Objectives

In this chapter, we tell you about:

- block transfer programming
- sample programs for the PLC-3 and PLC-5 processors

### Block Transfer Programming

Your module communicates with the processor through bidirectional block transfers. This is the sequential operation of both read and write block transfer instructions.

A configuration block transfer write (BTW) is initiated when the RTD module is first powered up, and subsequently only when the programmer wants to enable or disable features of the module. The configuration BTW sets the bits which enable the programmable features of the module, such as scaling, alarms, ranges, etc. Block transfer reads are performed to retrieve information from the module.

Block transfer read (BTR) programming moves status and data from the module to the processor's data table. The processor user program initiates the request to transfer data from the module to the processor. The transferred words contain module status, channel status and input data from the module.



**ATTENTION:** If the RTD module is not powered up before the remote I/O adapter, the adapter will not recognize the module. Make certain that the RTD module is installed and powered before or simultaneously with the remote I/O adapter. If the adapter does not establish communication with the module, cycle power to the adapter.

---

The following sample programs are minimum programs; all rungs and conditioning must be included in your application program. You can disable BTRs, or add interlocks to prevent writes if desired. Do not eliminate any storage bits or interlocks included in the sample programs. If interlocks are removed, the program may not work properly.

Your program should monitor status bits and block transfer read activity.

## Sample programs for Flex I/O Analog Modules

The following sample programs show you how to use your analog module efficiently when operating with a programmable controller.

These programs show you how to:

- configure the module
- read data from the module
- update the module’s output channels (if used)

These programs illustrate the minimum programming required for communication to take place.

### PLC-3 Programming

Block transfer instructions with the PLC-3 processor use one binary file in a data table section for module location and other related data. This is the block transfer control file. The block transfer data file stores data that you want transferred to your module (when programming a block transfer write) or from your module (when programming a block transfer read). The address of the block transfer data files are stored in the block transfer control file.

**The same block transfer control file is used for both the read and write instructions for your module.** A different block transfer control file is required for every module.

A sample program segment with block transfer instructions is shown in Figure 3.1, and described below.

**Figure 3.1**  
PLC-3 Family Sample Program Structure

#### Program Action

At power-up, in RUN mode, or when the processor is switched from PROG to RUN, the user program enables a block transfer read. Then it initiates a block transfer write to configure the module.

Thereafter, the program continuously performs read block transfers.

Note: You must create the data file for the block transfers before you enter the block transfer instructions.

The pushbutton allows the user to manually request a block transfer write.

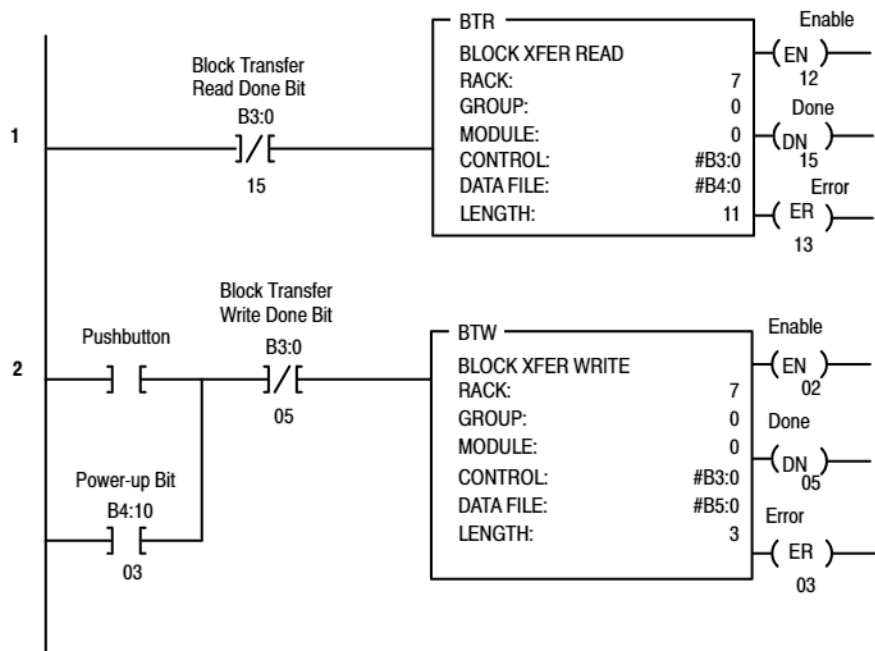

## PLC-5 Programming

The PLC-5 program is very similar to the PLC-3 program with the following exceptions:

- block transfer enable bits are used instead of done bits as the conditions on each rung.
- separate block transfer control files are used for the block transfer instructions.

**Figure 3.2**  
PLC-5 Family Sample Program Structure

### Program Action

At power-up, in RUN mode, or when the processor is switched from PROG to RUN, the user program enables a block transfer read. Then it initiates a block transfer write to configure the module.

Thereafter, the program continuously performs read block transfers.

The pushbutton allows the user to manually request a block transfer write.

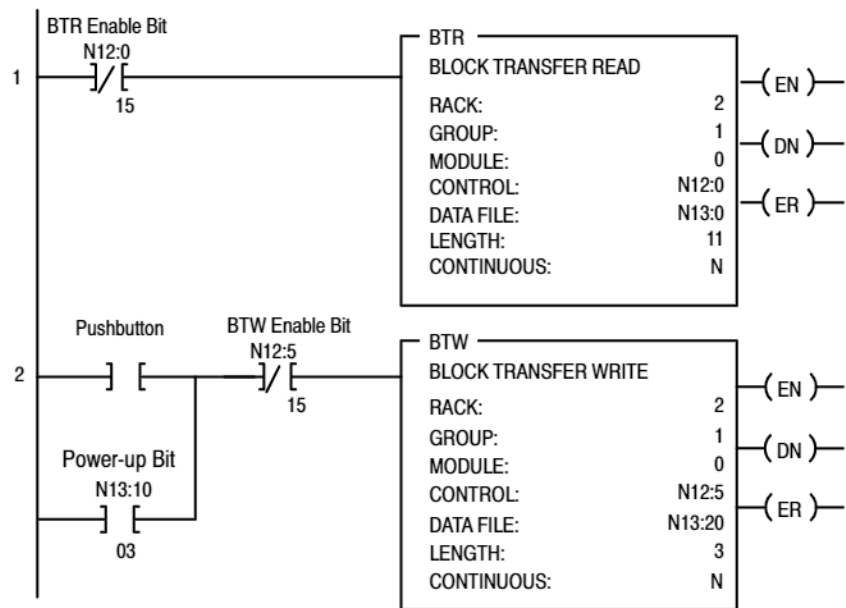

## PLC-2 Programming

The 1794 analog I/O modules are not recommended for use with PLC-2 family programmable controllers due to the number of digits needed for high resolution.

## Chapter Summary

In this chapter, we told you how to program your programmable controller. You were given sample programs for your PLC-3 and PLC-5 family processors.

## Writing Configuration to and Reading Status from Your Module with a Remote I/O Adapter

### Chapter Objectives

In this chapter, we tell you how:

- to configure your module's features
- to enter your data
- to read data from your module
- about the read block format

### Configuring Your RTD Module

The RTD module is configured using a group of data table words that are transferred to the module using a block transfer write instruction.

The software configurable features available are:

- input/output range selection, including full range and bipolar
- selectable first notch filter
- data reported in °F, °C, unipolar or bipolar count
- enhanced mode

**Note:** PLC-5 family programmable controllers that use 6200 software programming tools can take advantage of the IOCONFIG utility to configure these modules. IOCONFIG uses menu-based screens for configuration without having to set individual bits in particular locations. Refer to your 6200 software literature for details.

## Range Selection

Individual input channels are configurable to operate with the following sensor types:

Input Signal Range		
Resistance	1 to 433 $\Omega$	
RTD Input Signal Range	Alpha =	Degrees
100 ohm Pt (Euro)	0.00385	-200 to +870 $^{\circ}$ C
100 ohm Pt (U.S.)	0.003916	-200 to +630 $^{\circ}$ C
200 ohm Pt	0.00385	-200 to +630 $^{\circ}$ C
500 ohm Pt	0.00385	-200 to +630 $^{\circ}$ C
100 ohm Nickel	0.00618	-60 to +250 $^{\circ}$ C
120 ohm Nickel	0.00672	-80 to +290 $^{\circ}$ C
200 ohm Nickel	0.00618	-60 to +250 $^{\circ}$ C
500 ohm Nickel	0.00618	-60 to +250 $^{\circ}$ C
10 ohm Copper	0.00427	-200 to +260 $^{\circ}$ C

You select individual channel ranges using write words 1 and 2 of the block transfer write instruction.

## Input Scaling

Scaling lets you report each channel in actual engineering units. Scaled values are in integer format.

Range	Degrees	Counts	Maximum Resolution
+1 to 433 $\Omega$		10 to 4330	100m $\Omega$
100 ohm Pt Euro	-200 to +870 $^{\circ}$ C	-2000 to +8700	0.1 $^{\circ}$ C
100 ohm Pt U.S.	-200 to +630 $^{\circ}$ C	-2000 to +6300	0.1 $^{\circ}$ C
200 ohm Pt Euro	-200 to +630 $^{\circ}$ C	-2000 to +6300	0.1 $^{\circ}$ C
500 ohm Pt Euro	-200 to +630 $^{\circ}$ C	-2000 to +6300	0.1 $^{\circ}$ C
100 ohm Nickel	-60 to +250 $^{\circ}$ C	-600 to +2500	0.1 $^{\circ}$ C
120 ohm Nickel	-80 to +290 $^{\circ}$ C	-800 to +2900	0.1 $^{\circ}$ C
200 ohm Nickel	-60 to +250 $^{\circ}$ C	-600 to +2500	0.1 $^{\circ}$ C
500 ohm Nickel	-60 to +250 $^{\circ}$ C	-600 to +2500	0.1 $^{\circ}$ C
10 ohm Copper	-200 to +260 $^{\circ}$ C	-2000 to +26000	0.1 $^{\circ}$ C

Continued on next page

Range	Degrees	Counts	Maximum Resolution
100 ohm Pt Euro	-328 to +1598°F	-3280 to +15980	0.1°F
100 ohm Pt U.S.	-328 to +1166°F	-3280 to +11660	0.1°F
200 ohm Pt Euro	-328 to +1166°F	-3280 to +11660	0.1°F
500 ohm Pt Euro	-328 to +1166°F	-3280 to +11660	0.1°F
100 ohm Nickel	-76 to +482°F	-760 to +4820	0.1°F
120 ohm Nickel	-112 to +500°F	-1120 to +5000	0.1°F
200 ohm Nickel	-76 to +482°F	-760 to +4820	0.1°F
500 ohm Nickel	-76 to +482°F	-760 to +4820	0.1°F
10 ohm Copper	-328 to +500°F	-3280 to +5000	0.1°F

Note: Temperature data has an implied decimal point 1 space to the right of the last digit. (divide by 10). For example, a readout of 1779° would actually be 177.9°.

You select input scaling using the designated words of the write block transfer instruction. Refer to the Bit/Word description for write word 0, bits 00 and 01.

## Enhanced Mode

You can select an enhanced mode of operation for this module. The enhanced mode lets you determine the value of an unknown RTD input.

The voltage drop across a precision resistor in the module is taken once each sensor scan, and compared to the unknown input. The result is used to determine the value of the unknown RTD. This results in improved module temperature drift characteristics and accuracy.

However, since the comparison is done each program scan, the result is decreased module throughput.

## Hardware First Notch Filter

A hardware filter in the analog to digital converter lets you select a frequency for the first notch of the filter. Selection of the filter influences the analog to digital output data rate and changes the module throughput. Module throughput is a function of the number of inputs used and the first notch filter. Both of these influence the time from an RTD input to arrival at the flexbus backplane.

### Throughput in Normal Mode

A/D Filter First Notch Frequency (effective resolution)	10Hz (16-bits)	25Hz (16-bits)	50Hz (16-bits)	60Hz (16-bits)	100Hz (16-bits)	250Hz (13-bits)	500Hz (11-bits)	1000Hz (9-bits)
Number of channels scanned	System Throughput (in ms or s)							
1	325	145	85	75	55	37	31	28
2	650	290	170	150	110	74	62	56
3	975	435	255	225	165	111	93	84
4	1.3s	580	340	300	220	148	124	112
5	1.625s	725	425	375	275	185	155	140
6	1.95s	870	510	450	330	222	186	168
7	2.275s	1.015s	595	525	385	259	217	196
8	2.60s <sup>1</sup>	1.16s	680	600	440	296	248	224

<sup>1</sup> Default setting

### Throughput in Enhanced Mode

A/D Filter First Notch Frequency (effective resolution)	10Hz (16-bits)	25Hz (16-bits)	50Hz (16-bits)	60Hz (16-bits)	100Hz (16-bits)	250Hz (16-bits)	500Hz (11-bits)	1000Hz (9-bits)
Number of channels scanned	System Throughput (in ms or s)							
1	650	290	170	150	110	74	62	56
2	975	435	255	225	165	111	93	84
3	1.3s	580	340	300	220	148	124	112
4	1.625s	725	425	375	275	185	155	140
5	1.95s	870	510	450	330	222	186	168
6	2.275s	1.015s	595	525	385	259	217	196
7	2.60s	1.16s	680	600	440	296	248	224
8	2.925s <sup>1</sup>	1.305s	765	675	495	333	279	252

<sup>1</sup> Default setting

## Reading Data From Your Module

Read programming moves status and data from the RTD input module to the processor's data table in one I/O scan. The processor's user program initiates the request to transfer data from the RTD input module to the processor.

## Mapping Data for the Analog Modules

The following read and write words and bit/word descriptions describe the information written to and read from the RTD input module. The module uses up to 11 words of input data and up to 4 words of output data. Each word is composed of 16 bits.

### RTD Input Module (1794-IR8) Image Table Mapping

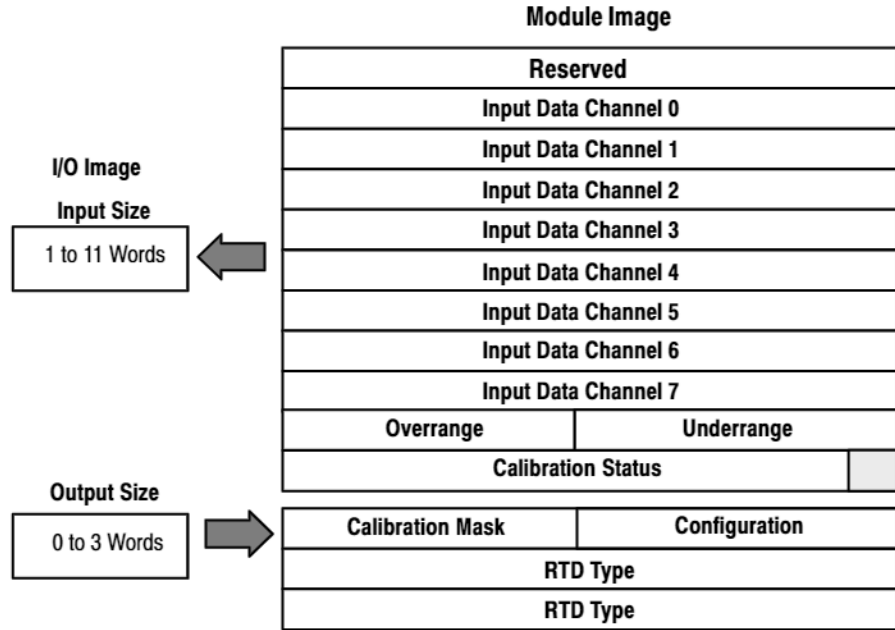

### RTD Analog Input Module (1794-IR8) Read Words

Decimal Bit	15	14	13	12	11	10	09	08	07	06	05	04	03	02	01	00
Octal Bit	17	16	15	14	13	12	11	10	07	06	05	04	03	02	01	00
Word 0	Reserved															
1	Channel 0 Input Data															
2	Channel 1 Input Data															
3	Channel 2 Input Data															
4	Channel 3 Input Data															
5	Channel 4 Input Data															
6	Channel 5 Input Data															
7	Channel 6 Input Data															
8	Channel 7 Input Data															
9	Overrange Bits								Underrange Bits							
10	0	0	0	0	0	Bad Cal	Cal Done	Cal Range	0	Diagnostic Status Bits		Pwr Up	Reserved	0	0	

### RTD Analog Input Module (1794-IR8) Write Words

Decimal Bit	15	14	13	12	11	10	09	08	07	06	05	04	03	02	01	00
Octal Bit	17	16	15	14	13	12	11	10	07	06	05	04	03	02	01	00
Word 0	8-bit Calibration Mask								Cal Clk	Cal Hi Cal Lo	Filter Cutoff			Enh	MDT	
1	RTD 3 Type				RTD 2 Type				RTD 1 Type				RTD 0 Type			
2	RTD 7 Type				RTD 6 Type				RTD 5 Type				RTD 4 Type			

Where: Enh = Enhanced  
MDT = Module Data Type

### Word/Bit Descriptions for the 1794-IR8 RTD Analog Input Module

Word	Dec. Bits (Octal Bits)	Description
Read Word 0	00-15 (00-17)	Reserved
Read Word 1	00-15 (00-17)	Channel 0 Input data
Read Word 2	00-15 (00-17)	Channel 1 Input data
Read Word 3	00-15 (00-17)	Channel 2 Input data
Read Word 4	00-15 (00-17)	Channel 3 Input data
Read Word 5	00-15 (00-17)	Channel 4 Input data
Read Word 6	00-15 (00-17)	Channel 5 Input data
Read Word 7	00-15 (00-17)	Channel 6 Input data
Read Word 8	00-15 (00-17)	Channel 7 Input data
Read Word 9	00-07	<b>Underrange bits</b> – these bits are set if the input signal is below the input channel's minimum range.
	08-15 (10-17)	<b>Overrange bits</b> – these bits are set if 1), the input signal is above the input channel's maximum range, or 2), an open detector is detected.
Read Word 10	00-01	Not used – set to 0
	02	Reserved
	03	<b>Powerup bit</b> – this bit is set (1) until configuration data is received by the module.
	04-06	<b>Critical Error bits</b> – If these bits are anything other than all zeroes, return the module to the factory for repair
	07	Unused – set to 0
	08 (10)	<b>Calibration Range bit</b> – set to 1 if a reference signal is out of range during calibration
	09 (11)	<b>Calibration Done bit</b> – set to 1 after an initiated calibration cycle is complete.
	10 (12)	<b>Calibration Bad bit</b> – set to 1 if the channel has not had a valid calibration.
11-15 (13-17)	Unused – set to 0	

Word	Dec. Bits (Octal Bits)	Description				
Write word 0	00-01	<b>Module Data Type</b>				
		<b>Bit</b>	<b>01</b>	<b>00</b>		
			0	0	°C (default)	
			0	1	°F	
			1	0	Bipolar counts scaled between -32768 and +32767	
		1	1	Unipolar counts scaled between 0 and 65535		
		02	<b>Enhanced mode select</b> - measures voltage drop across a precision resistor in the module to compare with the unknown input. This improves module temperature drift characteristics, but reduces module throughput.			
	03-05	<b>A/D Filter First Notch Frequency</b>				
		<b>Bit</b>	<b>05</b>	<b>04</b>	<b>03</b>	<b>Definition</b>
			0	0	0	10Hz (default)
			0	0	1	25Hz
			0	1	0	50Hz
			0	1	1	60Hz
			1	0	0	100Hz
		1	0	1	250Hz	
		1	1	0	500Hz	
	1	1	1	1000Hz		
	06	<b>Calibration High/Low bit</b> - This bit is set during gain calibration; reset during offset calibration.				
	07	<b>Calibration clock</b> - this bit must be set to 1 to prepare for a calibration cycle; then reset to 0 to initiate calibration.				
	08-15 (10-17)	<b>Calibration mask</b> - The channel, or channels, to be calibrated will have the correct mask bit set. Bit 8 corresponds to channel 0, bit 9 to channel 1, and so on.				

Word	Dec. Bits (Octal Bits)	Description					
Write Word 1	00-03	Channel 0 RTD Type					
		<b>Bit</b>	<b>03</b>	<b>02</b>	<b>01</b>	<b>00</b>	<b>RTD Type - Range</b>
			0	0	0	0	Resistance (default)
			0	0	0	1	No sensor connected - do not scan
			0	0	1	0	100 ohm Pt $\alpha = 0.00385$ Euro (-200 to +870°C)
			0	0	1	1	100 ohm Pt $\alpha = 0.003916$ U.S. (-200 to +630°C)
			0	1	0	0	200 ohm Pt $\alpha = 0.00385$ Euro (-200 to +630°C)
			0	1	0	1	500 ohm Pt $\alpha = 0.00385$ Euro (-200 to +630°C)
			0	1	1	0	Reserved
			0	1	1	1	10 ohm Copper (-200 to +260°C)
			1	0	0	0	120 ohm Nickel (-60 to +250°C)
			1	0	0	1	100 ohm Nickel (-60 to +250°C)
			1	0	1	0	200 ohm Nickel (-60 to +250°C)
			1	0	1	1	500 ohm Nickel (-60 to +250°C)
			1	1	0	0	Reserved
		1101 to 1111 - Reserved					
	04-07	Channel 1 RTD Type (see bits 00-03)					
	08-11	Channel 2 RTD Type (see bits 00-03)					
	12-15	Channel 3 RTD Type (see bits 00-03)					
Write Word 2	00-03	Channel 4 RTD Type (see write word 1, bits 00-03)					
	04-07	Channel 5 RTD Type (see write word 1, bits 00-03)					
	08-11	Channel 6 RTD Type (see write word 1, bits 00-03)					
	12-15	Channel 7 RTD Type (see write word 1, bits 00-03)					

## Chapter Summary

In this chapter, you learned how to configure your module's features and enter your data.

# How Communication Takes Place and I/O Image Table Mapping with the DeviceNet Adapter

## Chapter Objectives

In this chapter, we tell you about:

- DeviceNetManager software
- I/O structure
- image table mapping
- factory defaults

## About DeviceNetManager Software

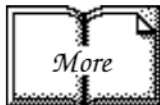

DeviceNetManager software is a tool used to configure your FLEX I/O DeviceNet adapter and its related modules. This software tool can be connected to the adapter via the DeviceNet network.

You must understand how DeviceNetManager software works in order to add a device to the network. Refer to the DeviceNetManager Software User Manual, publication 1787-6.5.3.

## Polled I/O Structure

Output data is received by the adapter in the order of the installed I/O modules. The Output data for Slot 0 is received first, followed by the Output data for Slot 1, and so on up to slot 7.

The first word of input data sent by the adapter is the Adapter Status Word. This is followed by the input data from each slot, in the order of the installed I/O modules. The Input data from Slot 0 is first after the status word, followed by Input data from Slot 2, and so on up to slot 7.

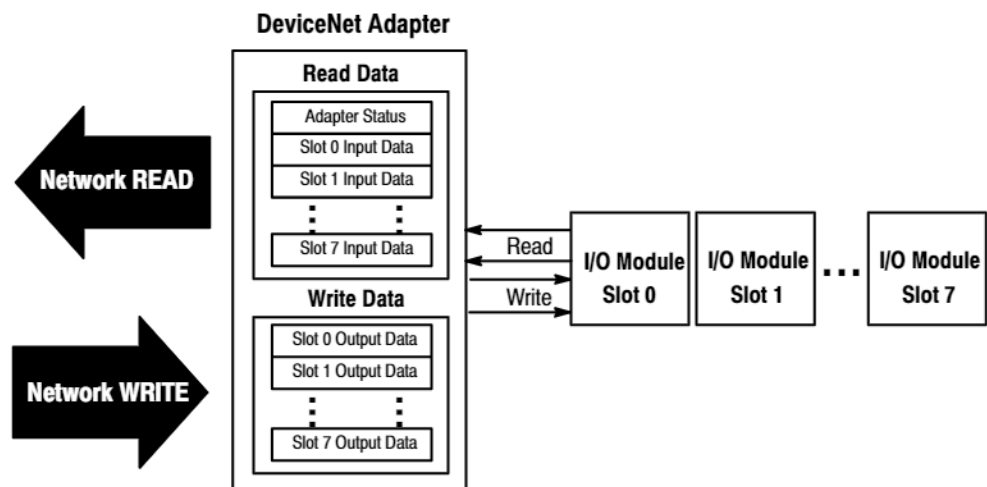

## Adapter Input Status Word

The input status word consists of:

- I/O module fault bits – 1 status bit for each slot
- node address changed – 1 bit
- I/O status – 1 bit

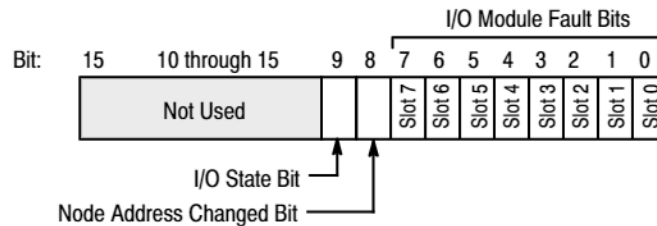

The adapter input status word bit descriptions are shown in the following table.

Bit Description	Bit	Explanation
I/O Module Fault	0	This bit is set (1) when an error is detected in slot position 0.
	1	This bit is set (1) when an error is detected in slot position 1.
	2	This bit is set (1) when an error is detected in slot position 2.
	3	This bit is set (1) when an error is detected in slot position 3.
	4	This bit is set (1) when an error is detected in slot position 4.
	5	This bit is set (1) when an error is detected in slot position 5.
	6	This bit is set (1) when an error is detected in slot position 6.
	7	This bit is set (1) when an error is detected in slot position 7.
Node Address Changed	8	This bit is set (1) when the node address switch setting has been changed since power up.
I/O State	9	Bit = 0 - idle Bit = 1 - run
	10 thru 15	Not used - sent as zeroes.

Possible causes for an **I/O Module Fault** are:

- transmission errors on the Flex I/O backplane
- a failed module
- a module removed from its terminal base
- incorrect module inserted in a slot position
- the slot is empty

The **node address changed** bit is set when the node address switch setting has been changed since power up. The new node address does not take effect until the adapter has been powered down and then powered back up.

## System Throughput

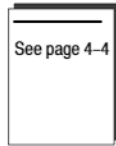

System throughput, from analog input to backplane, is a function of:

- the configured A/D filter first notch frequency
- the number of channels actually configured for connection to a specific sensor

The A/D converter which converts channel 0 through 7 analog data to a digital word provides a programmable first notch filter. You can set the position of the first notch of this filter during module configuration. The selection influences the A/D output data rate, thus affecting system throughput.

The number of channels included in each input scan also affects system throughput.

## Mapping Data into the Image Table

FLEX I/O RTD analog module data table mapping is shown below.

### RTD Input Analog Module (1794-IR8) Image Table Mapping

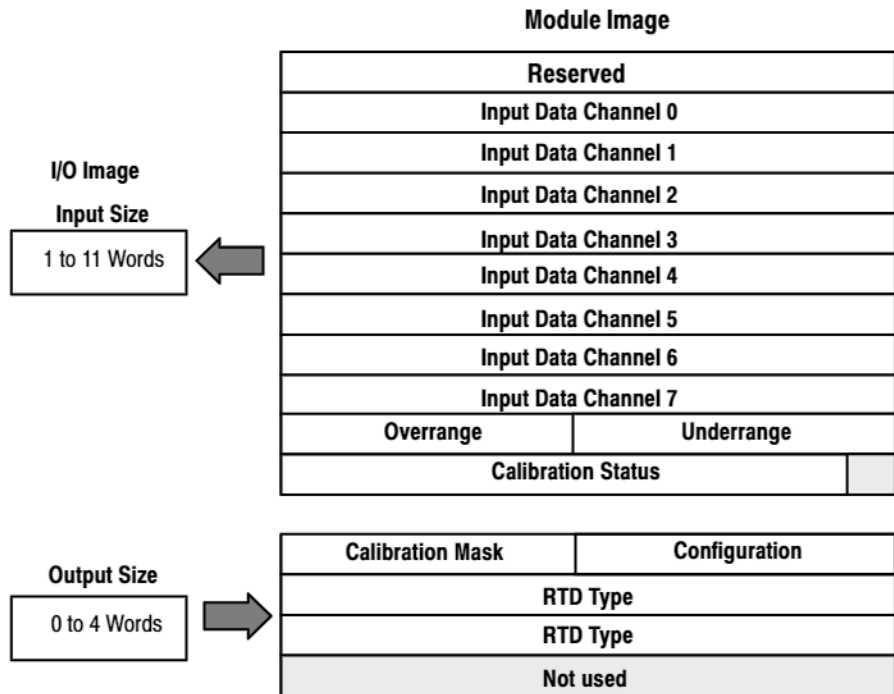

**Memory Map of RTD Analog Input Module  
Image Table – 1794-IR8**

Decimal Bit	15	14	13	12	11	10	09	08	07	06	05	04	03	02	01	00
Octal Bit	17	16	15	14	13	12	11	10	07	06	05	04	03	02	01	00
Read Word 1	Reserved															
2	Channel 0 Input Data															
3	Channel 1 Input Data															
4	Channel 2 Input Data															
5	Channel 3 Input Data															
6	Channel 4 Input Data															
7	Channel 5 Input Data															
8	Channel 6 Input Data															
9	Channel 7 Input Data															
10	Overrange Bits							Underrange Bits								
11	0	0	0	0	0	Bad Cal	Cal Done	Cal Range	0	Diagnostic Status Bits		Pwr Up	Reserved	0	0	
Write Word 1	8-bit Calibration Mask								Cal Clk	Cal Hi Cal Lo	Filter Cutoff		Enh	MDT		
2	RTD 3 Type				RTD 2 Type				RTD 1 Type				RTD 0 Type			
3	RTD 7 Type				RTD 6 Type				RTD 5 Type				RTD 4 Type			
4	Reserved – set to 0															

Where: Enh = Enhanced  
MDT = Module Data Type

**Word/Bit Descriptions for the 1794-IR8 RTD Analog  
Input Module**

Word	Decimal Bits (Octal Bits)	Description
Read Word 1	00–15 (00–17)	Reserved
Read Word 2	00–15 (00–17)	Channel 0 Input data
Read Word 3	00–15 (00–17)	Channel 1 Input data
Read Word 4	00–15 (00–17)	Channel 2 Input data
Read Word 5	00–15 (00–17)	Channel 3 Input data
Read Word 6	00–15 (00–17)	Channel 4 Input data
Read Word 7	00–15 (00–17)	Channel 5 Input data
Read Word 8	00–15 (00–17)	Channel 6 Input data
Read Word 9	00–15 (00–17)	Channel 7 Input data
Read Word 10	00–07	<b>Underrange bits</b> – these bits are set if the input signal is below the input channel's minimum range.
	08–15 (10–17)	<b>Overrange bits</b> – these bits are set if 1), the input signal is above the input channel's maximum range, or 2), an open detector is detected.

Word	Decimal Bits (Octal Bits)	Description																																													
Read Word 11	00-01	Not used - set to 0																																													
	02	Reserved																																													
	03	<b>Powerup bit</b> - this bit is set (1) until configuration data is received by the module.																																													
	04-06	<b>Critical Failure Bits</b> - If these bits are anything other than all zeroes, return the module to the factory for repair.																																													
	07	Unused - set to 0																																													
	08 (10)	<b>Calibration Range bit</b> - set to 1 if a reference signal is out of range during calibration																																													
	09 (11)	<b>Calibration Done bit</b> - set to 1 after an initiated calibration cycle is complete.																																													
	10 (12)	<b>Calibration Bad bit</b> - set to 1 if the channel has not had a valid calibration.																																													
	11-15 (13-17)	Unused - set to 0																																													
Write Word 1	00-01	<b>Module Data Type</b>																																													
		<table border="1"> <thead> <tr> <th>Bit</th> <th>01</th> <th>00</th> <th></th> </tr> </thead> <tbody> <tr> <td>0</td> <td>0</td> <td>0</td> <td>°C (default)</td> </tr> <tr> <td>0</td> <td>1</td> <td>0</td> <td>°F</td> </tr> <tr> <td>1</td> <td>0</td> <td>0</td> <td>Bipolar counts scaled between -32768 and +32767</td> </tr> <tr> <td>1</td> <td>1</td> <td>0</td> <td>Unipolar counts scaled between 0 and 65535</td> </tr> </tbody> </table>	Bit	01	00		0	0	0	°C (default)	0	1	0	°F	1	0	0	Bipolar counts scaled between -32768 and +32767	1	1	0	Unipolar counts scaled between 0 and 65535																									
		Bit	01	00																																											
		0	0	0	°C (default)																																										
		0	1	0	°F																																										
	1	0	0	Bipolar counts scaled between -32768 and +32767																																											
	1	1	0	Unipolar counts scaled between 0 and 65535																																											
	02	<b>Enhanced mode select</b> - measures voltage drop across a precision resistor in the module to compare with the unknown input.																																													
	03-05	<b>A/D Filter First Notch Frequency</b>																																													
		<table border="1"> <thead> <tr> <th>Bit</th> <th>05</th> <th>04</th> <th>03</th> <th>Definition</th> </tr> </thead> <tbody> <tr> <td>0</td> <td>0</td> <td>0</td> <td>0</td> <td>10Hz (default)</td> </tr> <tr> <td>0</td> <td>0</td> <td>0</td> <td>1</td> <td>25Hz</td> </tr> <tr> <td>0</td> <td>1</td> <td>0</td> <td>0</td> <td>50Hz</td> </tr> <tr> <td>0</td> <td>1</td> <td>1</td> <td>1</td> <td>60Hz</td> </tr> <tr> <td>1</td> <td>0</td> <td>0</td> <td>0</td> <td>100Hz</td> </tr> <tr> <td>1</td> <td>0</td> <td>1</td> <td>1</td> <td>250Hz</td> </tr> <tr> <td>1</td> <td>1</td> <td>0</td> <td>0</td> <td>500Hz</td> </tr> <tr> <td>1</td> <td>1</td> <td>1</td> <td>1</td> <td>1000Hz</td> </tr> </tbody> </table>	Bit	05	04	03	Definition	0	0	0	0	10Hz (default)	0	0	0	1	25Hz	0	1	0	0	50Hz	0	1	1	1	60Hz	1	0	0	0	100Hz	1	0	1	1	250Hz	1	1	0	0	500Hz	1	1	1	1	1000Hz
		Bit	05	04	03	Definition																																									
		0	0	0	0	10Hz (default)																																									
		0	0	0	1	25Hz																																									
		0	1	0	0	50Hz																																									
		0	1	1	1	60Hz																																									
		1	0	0	0	100Hz																																									
	1	0	1	1	250Hz																																										
1	1	0	0	500Hz																																											
1	1	1	1	1000Hz																																											
06	<b>Calibration High/Low bit</b> - This bit is set during gain calibration; reset during offset calibration.																																														
07	<b>Calibration clock</b> - this bit must be set to 1 to prepare for a calibration cycle; then reset to 0 to initiate calibration.																																														
08-15	<b>Calibration mask</b> - The channel, or channels, to be calibrated will have the correct mask bit set. Bit 8 corresponds to channel 0, bit 9 to channel 1, and so on.																																														

Word	Decimal Bits (Octal Bits)	Description																																																																																				
Write Word 2	00-03	Channel 0 RTD Type																																																																																				
		<table border="1"> <thead> <tr> <th>Bit</th> <th>03</th> <th>02</th> <th>01</th> <th>00</th> <th>RTD Type - Range</th> </tr> </thead> <tbody> <tr> <td>0</td> <td>0</td> <td>0</td> <td>0</td> <td>0</td> <td>Resistance (default)</td> </tr> <tr> <td>0</td> <td>0</td> <td>0</td> <td>0</td> <td>1</td> <td>No sensor connected - do not scan</td> </tr> <tr> <td>0</td> <td>0</td> <td>0</td> <td>1</td> <td>0</td> <td>100 ohm Pt <math>\alpha = 0.00385</math> Euro (-200 to +870°C)</td> </tr> <tr> <td>0</td> <td>0</td> <td>0</td> <td>1</td> <td>1</td> <td>100 ohm Pt <math>\alpha = 0.003916</math> U.S. (-200 to +630°C)</td> </tr> <tr> <td>0</td> <td>1</td> <td>0</td> <td>0</td> <td>0</td> <td>200 ohm Pt <math>\alpha = 0.00385</math></td> </tr> <tr> <td>0</td> <td>1</td> <td>0</td> <td>0</td> <td>1</td> <td>500 ohm Pt <math>\alpha = 0.00385</math></td> </tr> <tr> <td>0</td> <td>1</td> <td>1</td> <td>0</td> <td>0</td> <td>Reserved</td> </tr> <tr> <td>0</td> <td>1</td> <td>1</td> <td>1</td> <td>1</td> <td>10 ohm Copper (-200 to +260°C)</td> </tr> <tr> <td>1</td> <td>0</td> <td>0</td> <td>0</td> <td>0</td> <td>120 ohm Nickel</td> </tr> <tr> <td>1</td> <td>0</td> <td>0</td> <td>0</td> <td>1</td> <td>100 ohm Nickel</td> </tr> <tr> <td>1</td> <td>0</td> <td>0</td> <td>1</td> <td>0</td> <td>200 ohm Nickel</td> </tr> <tr> <td>1</td> <td>0</td> <td>0</td> <td>1</td> <td>1</td> <td>500 ohm Nickel</td> </tr> <tr> <td>1</td> <td>1</td> <td>1</td> <td>0</td> <td>0</td> <td>Reserved</td> </tr> </tbody> </table>	Bit	03	02	01	00	RTD Type - Range	0	0	0	0	0	Resistance (default)	0	0	0	0	1	No sensor connected - do not scan	0	0	0	1	0	100 ohm Pt $\alpha = 0.00385$ Euro (-200 to +870°C)	0	0	0	1	1	100 ohm Pt $\alpha = 0.003916$ U.S. (-200 to +630°C)	0	1	0	0	0	200 ohm Pt $\alpha = 0.00385$	0	1	0	0	1	500 ohm Pt $\alpha = 0.00385$	0	1	1	0	0	Reserved	0	1	1	1	1	10 ohm Copper (-200 to +260°C)	1	0	0	0	0	120 ohm Nickel	1	0	0	0	1	100 ohm Nickel	1	0	0	1	0	200 ohm Nickel	1	0	0	1	1	500 ohm Nickel	1	1	1	0	0	Reserved
		Bit	03	02	01	00	RTD Type - Range																																																																															
		0	0	0	0	0	Resistance (default)																																																																															
		0	0	0	0	1	No sensor connected - do not scan																																																																															
		0	0	0	1	0	100 ohm Pt $\alpha = 0.00385$ Euro (-200 to +870°C)																																																																															
		0	0	0	1	1	100 ohm Pt $\alpha = 0.003916$ U.S. (-200 to +630°C)																																																																															
		0	1	0	0	0	200 ohm Pt $\alpha = 0.00385$																																																																															
		0	1	0	0	1	500 ohm Pt $\alpha = 0.00385$																																																																															
		0	1	1	0	0	Reserved																																																																															
		0	1	1	1	1	10 ohm Copper (-200 to +260°C)																																																																															
		1	0	0	0	0	120 ohm Nickel																																																																															
		1	0	0	0	1	100 ohm Nickel																																																																															
		1	0	0	1	0	200 ohm Nickel																																																																															
		1	0	0	1	1	500 ohm Nickel																																																																															
1	1	1	0	0	Reserved																																																																																	
1101 to 1111 - Reserved																																																																																						
	04-07	Channel 1 RTD Type (see bits 00-03)																																																																																				
	08-11	Channel 2 RTD Type (see bits 00-03)																																																																																				
	12-15	Channel 3 RTD Type (see bits 00-03)																																																																																				
Write Word 3	00-03	Channel 4 RTD Type (see write word 2, bits 00-03)																																																																																				
	04-07	Channel 5 RTD Type (see write word 2, bits 00-03)																																																																																				
	08-11	Channel 6 RTD Type (see write word 2, bits 00-03)																																																																																				
	12-15	Channel 7 RTD Type (see write word 2, bits 00-03)																																																																																				
Write Word 4	00-15	Reserved																																																																																				

## Defaults

Each I/O module has default values associated with it. At default, each module will generate inputs/status and expect outputs/configuration.

Module Defaults for:		Factory Defaults		Real Time Size	
Catalog Number	Description	Input Default	Output Default	Input Default	Output Default
1794-IR8	8-Input RTD Input	11	4	9	0

**Factory defaults** are the values assigned by the adapter when you:

- first power up the system, and
- no previous stored settings have been applied.

For analog modules, the defaults reflect the actual number of input words/output words. For example, for the 8 RTD input analog module, you have 11 input words, and 4 output words.

You can change the I/O data size for a module by reducing the number of words mapped into the adapter module, as shown in “real time sizes.”

**Real time sizes** are the settings that provide optimal real time data to the adapter module.

Analog modules have 15 words assigned to them. This is divided into input words/output words. You can reduce the I/O data size to fewer words to increase data transfer over the backplane. For example, an 8 RTD input module has 11 words input/4 words output with factory default. You can reduce the write words to 0, thus eliminating the configuration setting and unused words. And you can reduce the read words to 9 by eliminating the underrange/overrange and calibration status words.

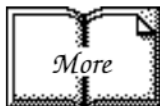

For information on using DeviceNetManager software to configure your adapter, refer to the DeviceNetManager Software User Manual, publication 1787-6.5.3.

## Calibrating Your Module

### Chapter Objective

In this chapter, we tell you how to calibrate your modules.

### When and How to Calibrate Your RTD Module

**Your module is shipped to you already calibrated.** If a calibration check is required, the module must be in a FLEX I/O system.

Perform module calibration periodically, based on your application.

Module calibration may also be required to remove module error due to aging of components in your system.

Offset calibration must be done first, followed by gain calibration.

Calibration can be accomplished using any of the following methods:

- manual calibration, as described below.
- 6200 I/O CONFIGURATION software – refer to your 6200 software publications for procedures for calibrating.
- DeviceNetManager Software – refer to your DeviceNet Manager software documentation for the DeviceNet Adapter Module, Cat. No. 1794-ADN. Some portion of this calibration is included here for use by users proficient with DeviceNet Adapter configuration software.

### Tools and Equipment

To calibrate your RTD input module, you will need the following tools and equipment:

Tool or Equipment	Description		
Precision Resistors  OR  Precision Decade Resistor Box	High Precision Resistors: 432Ω, 864Ω, 1728Ω, 0.01%, 5ppm/°C 1 ohm, 0.1%, 5ppm/°C	Lower Precision Resistors: If calibration to rated accuracy is not required, lower precision resistors can be used. Add percentage of tolerance and temperature coefficient error for expected accuracy.	
	Accuracy: Minimum three decades; Decade one – 10 ohm decade, 1 ohm per step, better than 0.005 ohms (0.5% accuracy) Decade two – 100 ohm decade, 10 ohm per step, better than 0.005 ohms (0.05% accuracy) Decade three – 1000 ohm decade, 100 ohm per step, better than 0.01% accuracy		
	Any vendor's model that meets or exceeds the above specifications can be used. The user is responsible for assuring that the decade box maintains accuracy by periodic calibration as specified by the vendor. As a service to its customers, Allen-Bradley offers this partial list of vendors who can supply decade resistor boxes that meet or exceed the specifications.		
	Electro Scientific Industries Portland, OR Series DB 42	IET Labs Westbury, NY HARS-X Series	Julie Research Labs New York, NY DR 100 Series
Industrial Terminal and Interconnect Cable	Programming terminal for A-B family processors		

## Manually Calibrating your RTD Input Module

You must calibrate the module in a Flex I/O system. The module must communicate with the processor and an industrial terminal. You can calibrate input channels in any order, or all at once.

Before calibrating your module, you must enter ladder logic into the processor memory, so that you can initiate block transfer writes (BTW) to the module, and read inputs from the module (BTR).

**Important:** To allow the internal module temperature to stabilize, apply power to the module for at least 40 minutes before calibrating.

To manually calibrate the module:

1. Apply a reference to the desired input(s).
2. Send a message to the module indicating which inputs to read and what calibration step is being performed (offset).

The module stores this input data.

3. Apply a second reference signal to the module.
4. Send a second message indicating which inputs to read and what calibration step is being performed (gain).

The module computes new calibration values for the inputs. Once the calibration is complete, the module reports back status information about the procedure.

The following flow chart shows the procedure for calibration.

**Important:** Perform the offset calibration procedure first, then the gain calibration procedure.

**Flow Chart for Calibration Procedure**

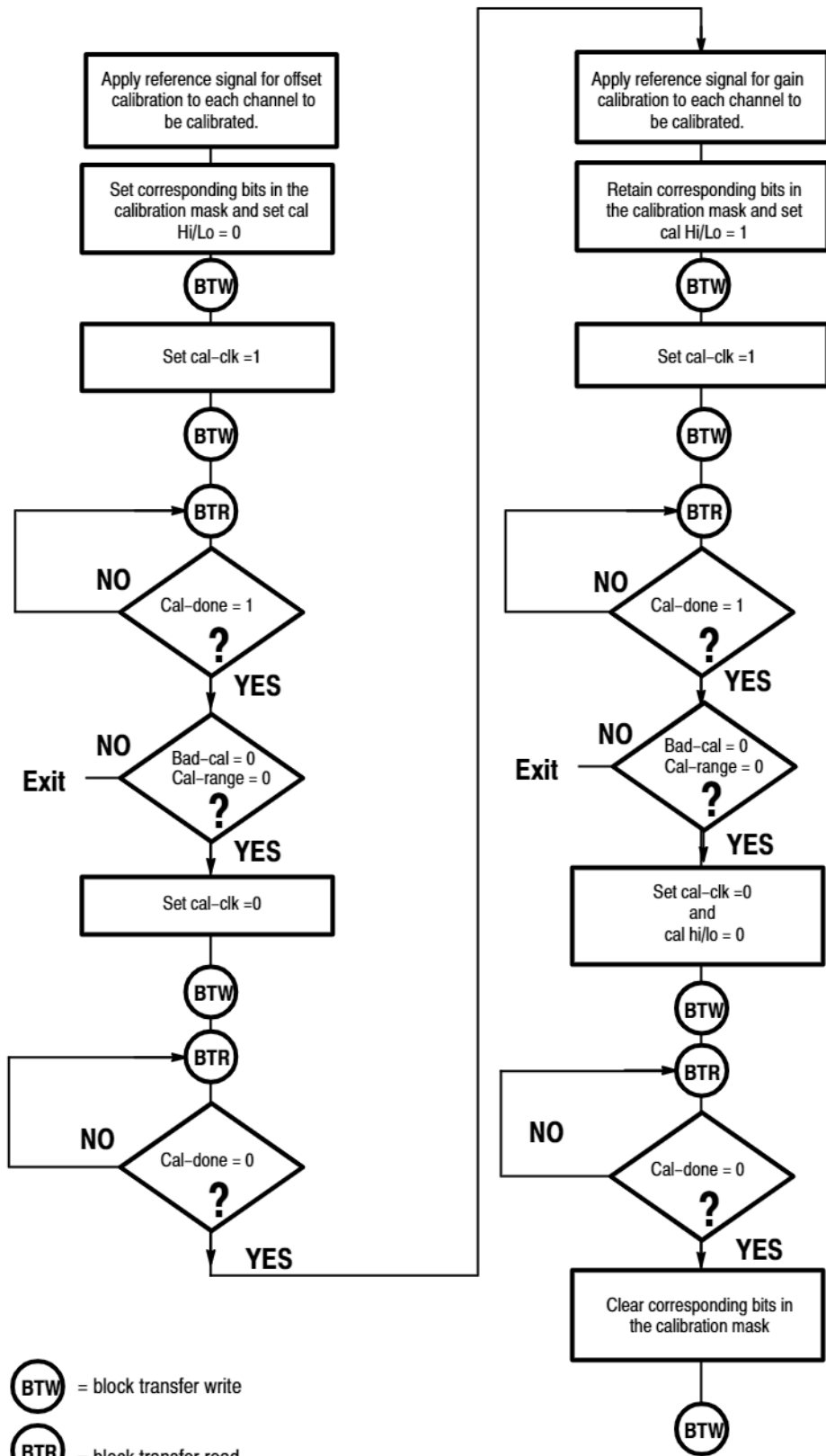

### Calibration Setups

#### Using Resistors

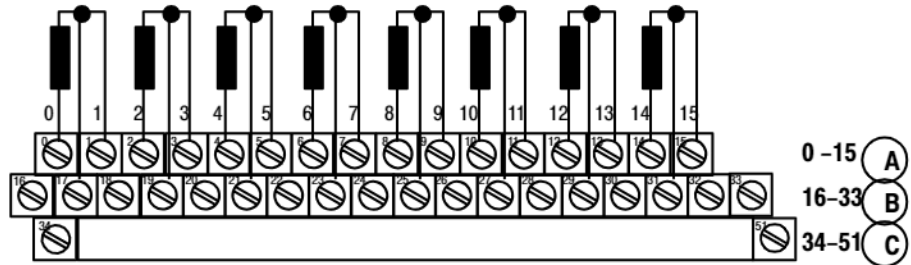

#### Using a Decade Box

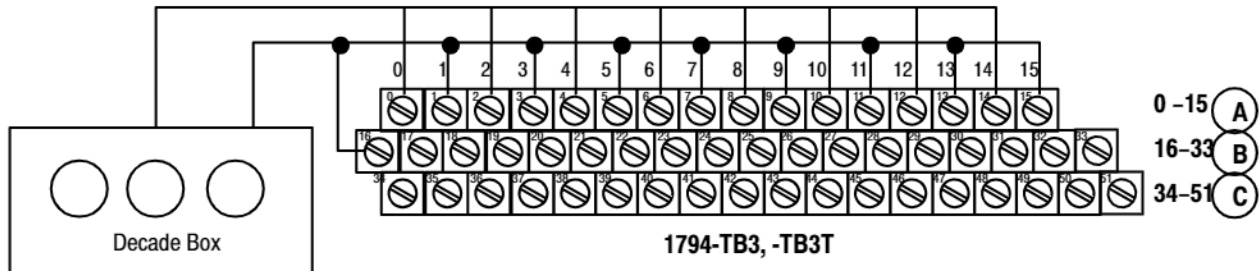

### Wiring Connections for the RTD Module

RTD Channel	1794-TB2 and -TB3 Terminal Base Units				1794-TB3T Terminal Base Unit			
	High Signal Terminal	Low Signal Terminal	Signal Return <sup>1</sup>	Shield Return	High Signal Terminal	Low Signal Terminal	Signal Return	Shield Return <sup>2</sup>
0	0	1	17	18	0	1	17	39
1	2	3	19	20	2	3	19	40
2	4	5	21	22	4	5	21	41
3	6	7	23	24	6	7	23	42
4	8	9	25	26	8	9	25	43
5	10	11	27	28	10	11	27	44
6	12	13	29	30	12	13	29	45
7	14	15	31	32	14	15	31	46
24V dc Common	16 thru 33				16, 17, 19, 21, 23, 25, 27, 29, 31 and 33			
+24V dc power	1794-TB2 – 34 and 51; 1794-TB3 – 34 thru 51				34, 35, 50 and 51			
<sup>1</sup> When using a 2-wire RTD, jumper the signal return to the low signal terminal.					<sup>2</sup> Terminals 39 to 46 are chassis ground.			

### Read/Write Words for Calibration

Decimal Bit	15	14	13	12	11	10	09	08	07	06	05	04	03	02	01	00
Octal Bit	17	16	15	14	13	12	11	10	07	06	05	04	03	02	01	00
Read Word 10	0	0	0	0	0	Bad Cal	Cal Done	Cal Range	0	Diagnostic Status Bits			Pwr Up	Reserved	0	0
Write Word 0	8-bit Calibration Mask								Cal Clk	Cal Hi	Cal Lo	Filter Cutoff		Enh	MDT	

## Offset Calibration

Inputs can be calibrated one at a time or all at once. To calibrate the offsets for all inputs at once, proceed as follows:

1. Connect 1.00 ohm resistors across each input channel. Connect the low signal side to 24V dc common. (If using a decade box, connect all high signal terminals together and attach to one lead from the decade box. Connect all low signal terminals together and attach to the other lead and to 24V dc common. Set the decade box for 1.00 ohm.)
2. Apply power to the module for 40 minutes before calibrating.
3. After the connections stabilize, use a block transfer write to set the bit(s) in the calibration mask that correspond to the channel(s) you want to calibrate to 1. (Bits 08 through 15 in write word 0.)
4. Send another block transfer write to set the cal-clk bit (07 in write word 0) to 1.
5. Monitor the cal-done bit (09 in read word 10). If the calibration is successful, the cal-done bit will be set to 1. Verify that the bad-cal bit (10 in read word 10) and the cal-range bit (08 in read word 10) are not set (0).
6. Send another block transfer write to set the cal-clk bit (07 in write word 0) to 0.
7. Monitor the cal-done bit (09 in read word 10). The cal-done bit will be reset to 0.
8. If the calibration is successful, proceed to the gain calibration.

## Gain Calibration

After completing the offset calibration, proceed with the gain calibration.

1. Connect resistors across each input channel. Connect the low signal side to 24V dc common. (Resistor values are shown in table 6.A.) (If using a decade box, connect all high signal terminals together and attach to one lead from the decade box. Connect all low signal terminals together and attach to the other lead and to 24V dc common. Set the decade box for the value shown in table 6.A.)

**Table 6.A Calibration Resistance/Voltage Values for the 1794-IR8**

Type of RTD	Analog/Digital Gain <sup>1</sup>	Offset Calibration Value (Ideal Counts)	Gain Calibration	Ideal Unipolar Analog/Digital Counts
100Ω Pt. (alpha = 0.00385) 100Ω Pt. (alpha = 0.003916) 120Ω Nickel (alpha = 0.00672) 100Ω Nickel (alpha = 0.00618) 10Ω Copper (alpha = 0.00427)	8 (default)	1Ω, 0.1%, 5ppm/°C	432Ω, 0.01%, 5ppm/°C	65084 (H'FE3C)
200Ω Pt. (alpha = 0.00385) 200Ω Nickel (alpha = 0.00618)	4	1Ω, 0.1%, 5ppm/°C	864Ω, 0.01%, 5ppm/°C	65084 (H'FE3C)
500Ω Pt. (alpha = 0.00385) 500Ω Nickel (alpha = 0.00618)	2	1Ω, 0.1%, 5ppm/°C	1728Ω, 0.01%, 5ppm/°C	65084 (H'FE3C)

<sup>1</sup> Gain is automatically set when RTD is selected.

2. Apply power to the module for 40 minutes before calibrating.
3. After the connections stabilize, send a block transfer write to the module to set the bit in the calibration mask that corresponds to the channel to be calibrated to 1, and the hi/lo bit (bit 06 in write word 0) to 1. (Set bits 08 through 15 in write word 0 if calibrating all inputs at one time.)
4. Send another block transfer write to set the cal-clk bit (07 in write word 0) to 1.
5. Monitor the cal-done bit (09 in read word 10). If the calibration is successful, the cal-done bit will be set to 1. Verify that the bad-cal bit (10 in read word 10) and the cal-range bit (08 in read word 10) are not set (0).
6. Send another BTW to set the cal-clk bit (07 in write word 0) to 0.
7. Send another BTW to set the hi/lo bit (bit 06 in write word 0) to 0.
8. Monitor the cal-done bit (09 in read word 10). The cal-done bit will be reset to 0.

9. If individually calibrating channels, repeat steps 1 through 7 for offset calibration on any additional channels you want to calibrate.
10. Send a block transfer write to the module to clear all calibration mask bits to 0.

## Calibrating Your RTD Module using DeviceNet Manager Software (Cat. No. 1787-MGR)

The following procedure assumes that you are using DeviceNet Manager software (cat. no. 1787-MGR) and have the RTD module installed in a working system.

Calibration is performed in the following order:

- offset calibration
- gain calibration

### Offset Calibration

Inputs can be calibrated one at a time or all at once. To calibrate the offsets for all inputs at once:

1. Connect 1.00 ohm resistors across each input channel. Connect the low signal side to 24V dc common. (If using a decade box, connect all high signal terminals together and attach to one lead from the decade box. Connect all low signal terminals together and attach to the other lead and to 24V dc common. Set the decade box for 1.00 ohm)
2. Apply power to the module for 40 minutes before calibrating.
3. Click on Configure for the slot containing the RTD module.

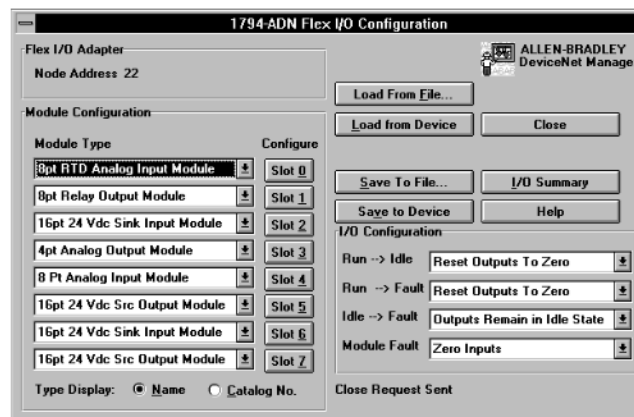

The following screen appears:

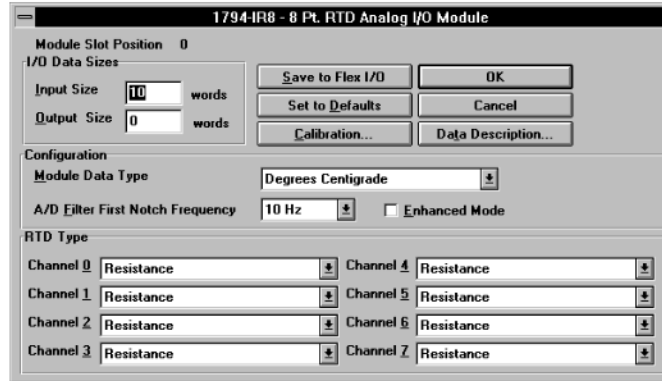

4. Click on  to get to the calibration screen.

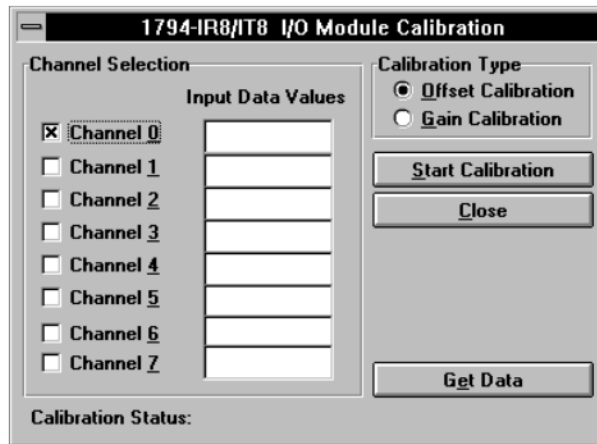

5. Click on the channels you want to calibrate.
6. Click on the radio button  for offset calibration. Then click on

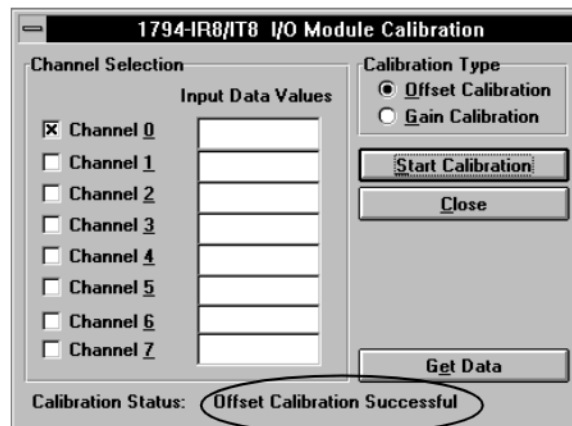

7. When calibration is complete, a notification will appear on the calibration status line.

8. If calibration was not completed successfully, you will see a popup similar to the following:



9. To see what the values are for the channels, click on the  button. This populates the screen with the actual values appearing at the inputs. Note that there is an implied decimal point before the last digit in the value. For example, channel 0 data value reads 10. The actual reading is 1.0. The -1 indications on the remaining channels indicate open channels.

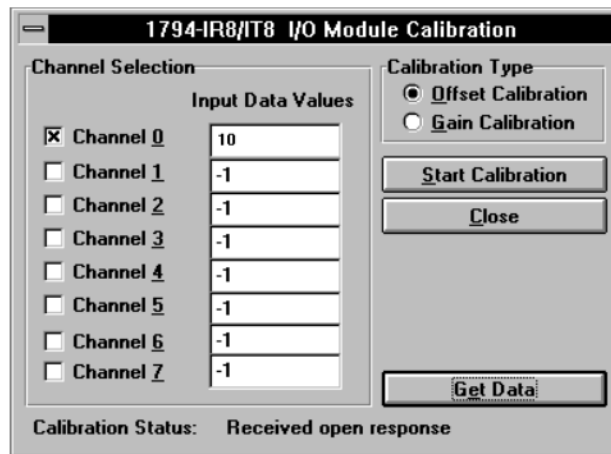

## Gain Calibration

Make sure that you have calibrated the offset for this channel before calibrating the gain.

1. Connect resistors across each input channel. Connect the low signal side to 24V dc common. (Resistor values are shown in table 6.A.) (If using a decade box, connect all high signal terminals together and attach to one lead from the decade box. Connect all low signal terminals together and attach to the other lead and to 24V dc common. Set the decade box for the value shown in table 6.A.)
2. Click on the channels you want to calibrate.
3. Click on the radio button  for gain calibration. Then click on

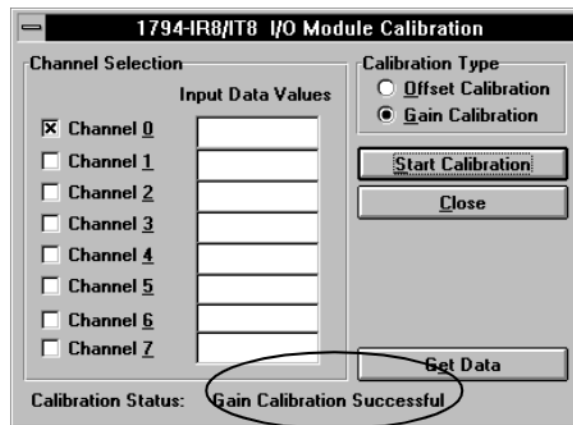

4. When calibration is complete, a notification will appear on the calibration status line.

The  button populates the screen with the actual values appearing at the inputs. Note that there is an implied decimal point before the last digit in the value. For example, if channel 0 data value reads 6299. The actual reading is 629.9.

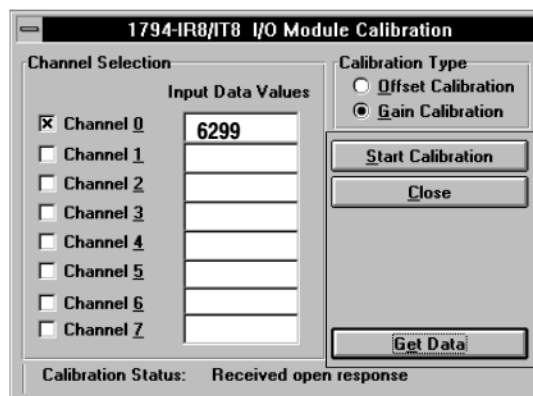

After both offset and gain calibrations are successful, click on



You will be returned to the module configuration screen. Either “Save to Flex I/O” (adapter), or save to a file by clicking on the appropriate button.

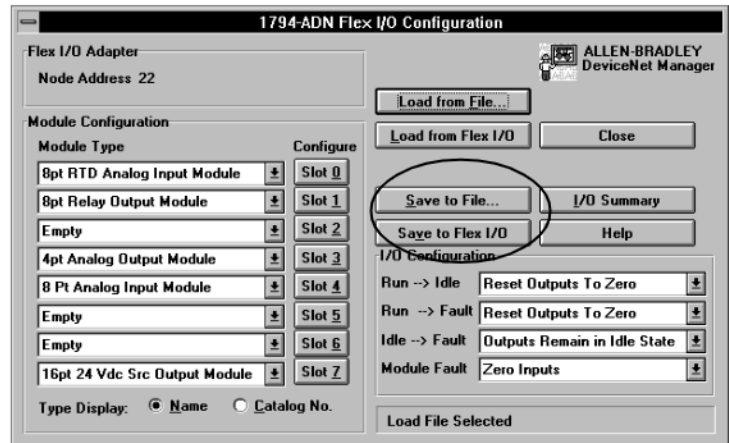

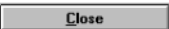
If you attempt to close without saving your configuration information by clicking on the  button, you will be prompted to save the changes.



## Specifications

<b>Specifications – 1794-IR8 RTD Input Module</b>	
Number of Inputs	8 Channels
Module Location	Cat. No. 1794-TB2, -TB3, -TB3T Terminal Base Unit
Signal Input Range	1 to 433 ohms
Sensors Supported	Resistance: 100 ohm Pt $\alpha = 0.00385$ Euro (-200 to +870°C) 100 ohm Pt $\alpha = 0.003916$ U.S. (-200 to +630°C) 200 ohm Pt $\alpha = 0.00385$ Euro (-200 to +630°C) 500 ohm Pt $\alpha = 0.00385$ Euro (-200 to +630°C) 100 ohm Nickel $\alpha = 0.00618$ (-60 to +250°C) 120 ohm Nickel $\alpha = 0.00672$ (-60 to +250°C) 200 ohm Nickel $\alpha = 0.00618$ (-60 to +250°C) 500 ohm Nickel $\alpha = 0.00618$ (-60 to +250°C) 10 ohm Copper $\alpha = 0.00427$ (-200 to +260°C)
Resolution	16 bits across 435 ohms
Data Format	16-bit 2's complement or offset binary (unipolar)
Normal Mode Noise Rejection	60db @ 60Hz for A/D filter cutoff @ 10Hz
Accuracy without calibration (at low humidity)	Normal mode: 0.05% Full Scale (maximum) Enhanced mode: 0.01% Full Scale (typical)
Common Mode Rejection	-120db @ 60Hz; -100db @ 50Hz with A/D filter cutoff @ 10Hz
Common Mode Voltage	0V between channels (common return)
System Throughput	
Normal mode:	Programmable from 28ms/channel to 325ms/channel 325ms (1 channel scanned) 2.6s (8 channels scanned) – default
Enhanced mode:	Programmable from 56ms/channel to 650ms/channel 650ms (1 channel scanned) – default 2.925s (8 channels scanned)
Settling Time to 100% of final value	Available at system throughput rate
Open RTD Detection	Out of range reading (upscale)
Open Wire Detection Time	Available at system throughput rate
Overvoltage Capability	35V dc, 25V ac continuous @ 25°C 250V peak transient
Channel Bandwidth	dc to 2.62Hz (-3db)
RFI Immunity	Error of less than 1% of range at 10V/M 27 to 1000MHz
Input Offset Drift with Temperature	1.5 milliohm/°C maximum
<b>Specifications continued on next page.</b>	

### Specifications – 1794-IR8 RTD Input Module

Gain Drift with Temperature	Normal mode: 20 ppm/°C maximum Enhanced mode: 10 ppm/°C maximum
RTD Excitation Current	718.39 $\mu$ A
Indicators	1 red/green status indicator
Flexbus Current	20mA
Power Dissipation	3W maximum @ 31.2V dc
Thermal Dissipation	Maximum 10.2 BTU/hr @ 31.2V dc
Keyswitch Position	3

#### General Specifications

External dc Power		
Supply Voltage	24V dc nominal	
Voltage Range	19.2 to 31.2V dc (includes 5% ac ripple)	
	19.2V dc for ambient temperatures less than 55°C	
	24V dc for ambient temperatures less than 55°C	
	31.2V dc for ambient temperatures less than 40°C	
	See derating curve.	
Supply Current	140mA @ 24V dc	
Dimensions	Inches	1.8H x 3.7W x 2.1D
	(Millimeters)	(45.7 x 94.0 x 53.3)
Environmental Conditions		
Operational Temperature		0 to 55°C (32 to 131°F) See derating curve.
Storage Temperature		-40 to 85°C (-40 to 185°F)
Relative Humidity		5 to 95% noncondensing (operating)
		5 to 80% noncondensing (nonoperating)
Shock	Operating	30 g peak acceleration, 11(+1)ms pulse width
	Nonoperating	50 g peak acceleration, 11(+1)ms pulse width
Vibration		Tested 5 g @ 10–500Hz per IEC 68-2-6
Agency Certification (when product or packaging is marked)		<ul style="list-style-type: none"> <li>• CSA certified</li> <li>• CSA Class I, Division 2, Groups A, B, C, D certified</li> <li>• UL listed</li> <li>• CE marked for all applicable directives</li> </ul>
Installation Instructions		Publication 1794-5.22

### RTD Accuracy at Worst Case

RTD Type	Alpha $\alpha =$	Worst Case Accuracy				Resolution (°C) (°F)	
		Normal Mode (°C) (°F)		Enhanced Mode (°C) (°F)			
100 ohm Pt (Euro)	0.00385	0.56	1.0	0.280	0.5	0.017	0.031
100 ohm Pt (U.S.)	0.003916	0.55	1.0	0.275	0.5	0.017	0.03
200 ohm Pt	0.00385	0.56	1.0	0.280	0.5	0.034	0.062
500 ohm Pt	0.00385	0.56	1.0	0.280	0.5	0.069	0.124
100 ohm Nickel	0.00618	0.35	0.63	0.175	0.32	0.01	0.018
120 ohm Nickel	0.00672	0.32	0.58	0.160	0.29	0.01	0.02
200 ohm Nickel	0.00618	0.35	0.63	0.175	0.32	0.02	0.039
500 ohm Nickel	0.00618	0.35	0.63	0.175	0.32	0.043	0.077
10 ohm Copper	0.00427	0.51	0.92	0.225	0.46	0.015	0.28

### Derating Curve

User Applied 24V dc Supply versus Ambient Temperature

The area within the curve represents the safe operating range for the module under various conditions of user supplied 24V dc supply voltages and ambient temperatures.

 = Safe operating area

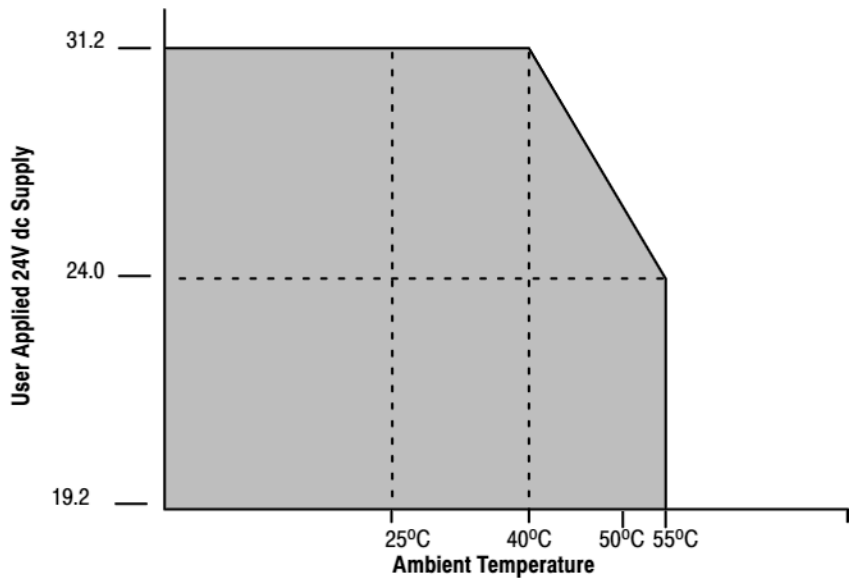

## Symbols

\*\*Empty\*\*, [1](#), [P-1](#), [P-2](#), [1-1](#), [1-3](#),  
[2-1](#), [3-3](#), [5-3](#), [6-1](#), [A-3](#), [6-1](#)

## A

accuracy, worst case, [A-3](#)  
adapter input status word, [5-1](#)  
audience, [P-1](#)

## B

bit/word description, RTD analog module,  
1794-IR8, [4-6](#), [5-4](#)  
block transfer  
  read, [1-2](#)  
  write, [1-2](#)  
block transfer programming, [3-1](#)  
block transfer read, [4-4](#)  
  1794-IR8, [4-5](#)  
block transfer write  
  1794-IR8, [4-6](#)  
  configuration block, 1794-IR8, [4-6](#)  
  input range selection, [4-2](#)

## C

calibration  
  gain, [6-6](#)  
  manual, [6-2](#)  
  offset, [6-5](#)  
  periodic, [6-1](#)  
  preparation, [6-2](#)  
  setups, [6-4](#)  
  tools, [6-1](#)  
  types of, [6-1](#)  
  using decade box, [6-4](#)  
  using DeviceNet Manager, [6-7](#)  
  using resistors, [6-4](#)  
calibration flow chart, [6-3](#)  
calibration resistance/voltage values, table  
  of, [6-6](#)  
calibration words, [6-4](#)  
communication, between module and  
  adapter, [1-2](#)  
compatible terminal bases, [2-5](#)  
configurable features, [4-1](#)

connecting wiring, [2-5](#), [6-4](#)  
considerations, pre-installation, [2-1](#)  
current draw, through base units, [2-2](#)  
curve, supply voltage vs ambient  
  temperature, [A-3](#)

## D

daisy-chaining wiring, [2-3](#)  
default values, [5-7](#)  
derating curve, [A-3](#)  
DeviceNet Manager, software, [5-1](#)  
DeviceNet Manager software, [6-7](#)

## E

enhanced mode, [4-3](#)  
example  
  RTD/1794-TB3, [2-7](#)  
  RTD/1794-TB3A, [2-7](#)

## F

features, of the module, [1-3](#)  
first notch filter, [4-4](#)  
flow chart, calibration, [6-3](#)

## G

gain calibration, [6-6](#)  
  using DeviceNet Manager, [6-10](#)

## I

I/O module fault, [5-2](#)  
indicators  
  states, [2-8](#)  
  status, [2-8](#)  
input ranges, [4-2](#)  
input scaling, [4-2](#)  
input status word, [5-2](#)  
installation, module, [2-4](#)

**K**

keyswitch positions, [2-4](#)

**M**

manual calibration, [6-2](#)

mapping

1794-IR, [4-5](#)

1794-IR8, [5-3](#)

memory map, 1794-IR8, [5-4](#)

module, shipping state, [6-1](#)

module fault, [5-2](#)

module features, [1-3](#)

module installation, [2-4](#)

**O**

offset calibration, [6-5](#)

using DeviceNet Manager, [6-7](#)

optimal defaults, [5-7](#)

**P**

PLC-2 programming, [3-3](#)

polled I/O, structure, [5-1](#)

power defaults, [5-7](#)

preparing for calibration, [6-2](#)

programming example

PLC-3, [3-2](#)

PLC-5, [3-3](#)

**R**

range, selecting, [4-2](#)

read/write words, for calibration, [6-4](#)

removing and replacing, under power (RIUP), [2-4](#)

RTD

accuracy at worst case, [A-3](#)

specifications, [A-1](#)

RTD analog input mapping

1794-IR, [4-5](#)

1794-IR8, [5-3](#)

RTD/1794-TB3 example, [2-7](#)

RTD/1794-TB3A example, [2-7](#)

**S**

sample program, [3-3](#)

scaling, [4-2](#)

software, DeviceNet Manager, [5-1](#)

specifications, [A-1](#)

status indicators, [2-8](#)

system throughput, [5-3](#)

**T**

terminal bases, compatible, [2-5](#)

throughput

enhanced mode, [4-4](#)

normal mode, [4-4](#)

**W**

wiring

connections, [6-4](#)

methods of, [2-3](#)

to terminal bases, [2-1](#)

wiring connections, [2-5](#)

1794-IR8, [2-6](#), [6-4](#)

worst case accuracy, [A-3](#)



# Allen-Bradley Publication Problem Report

If you find a problem with our documentation, please complete and return this form.

Pub. Name RTD Module User Manual

Cat. No. 1794-IR8 Pub. No. 1794-6.5.4 Pub. Date January 1996 Part No. 955119-77

Check Problem(s) Type:	Describe Problem(s):	Internal Use Only
<input type="checkbox"/> Technical Accuracy	<input type="checkbox"/> text <input type="checkbox"/> illustration	
<input type="checkbox"/> Completeness What information is missing?	<input type="checkbox"/> procedure/step <input type="checkbox"/> illustration <input type="checkbox"/> definition <input type="checkbox"/> example <input type="checkbox"/> guideline <input type="checkbox"/> feature <input type="checkbox"/> explanation <input type="checkbox"/> other	<input type="checkbox"/> info in manual (accessibility) <input type="checkbox"/> info not in manual
<input type="checkbox"/> Clarity What is unclear?		
<input type="checkbox"/> Sequence What is not in the right order?		
<input type="checkbox"/> Other Comments Use back for more comments.		

Your Name \_\_\_\_\_ Location/Phone \_\_\_\_\_

Return to: Marketing Communications, Allen-Bradley Co., 1 Allen-Bradley Drive, Mayfield Hts., OH 44124-6118 Phone: (216)646-3176  
FAX: (216)646-4320

PLEASE FASTEN HERE (DO NOT STAPLE)

Other Comments

PLEASE FOLD HERE

PLEASE REMOVE



NO POSTAGE  
NECESSARY  
IF MAILED  
IN THE  
UNITED STATES



**BUSINESS REPLY MAIL**

FIRST-CLASS MAIL PERMIT NO. 18235 CLEVELAND OH

POSTAGE WILL BE PAID BY THE ADDRESSEE



**Allen-Bradley**

TECHNICAL COMMUNICATION  
1 ALLEN BRADLEY DR  
MAYFIELD HEIGHTS OH 44124-9705



## **Support Services**

At Allen-Bradley, customer service means experienced representatives at Customer Support Centers in key cities throughout the world for sales service and support. Our value-added services include:

### **Technical Support**

- SupportPlus programs
- telephone support and 24-hour emergency hotline
- software and documentation updates
- technical subscription services

### **Engineering and Field Services**

- application engineering assistance
- integration and start-up assistance
- field service
- maintenance support

### **Technical Training**

- lecture and lab courses
- self-paced computer and video-based training
- job aids and workstations
- training needs analysis

### **Repair and Exchange Services**

- your only “authorized” source
- current revisions and enhancements
- worldwide exchange inventory
- local support



Allen-Bradley, a Rockwell Automation Business, has been helping its customers improve productivity and quality for more than 90 years. We design, manufacture and support a broad range of automation products worldwide. They include logic processors, power and motion control devices, operator interfaces, sensors and a variety of software. Rockwell is one of the world's leading technology companies.



## Worldwide representation.

Argentina • Australia • Austria • Bahrain • Belgium • Brazil • Bulgaria • Canada • Chile • China, PRC • Colombia • Costa Rica • Croatia • Cyprus • Czech Republic • Denmark • Ecuador • Egypt • El Salvador • Finland • France • Germany • Greece • Guatemala • Honduras • Hong Kong • Hungary • Iceland • India • Indonesia • Ireland • Israel • Italy • Jamaica • Japan • Jordan • Korea • Kuwait • Lebanon • Malaysia • Mexico • Netherlands • New Zealand • Norway • Pakistan • Peru • Philippines • Poland • Portugal • Puerto Rico • Qatar • Romania • Russia-CIS • Saudi Arabia • Singapore • Slovakia • Slovenia • South Africa, Republic • Spain • Sweden • Switzerland • Taiwan • Thailand • Turkey • United Arab Emirates • United Kingdom • United States • Uruguay • Venezuela • Yugoslavia

Allen-Bradley Headquarters, 1201 South Second Street, Milwaukee, WI 53204 USA, Tel: (1) 414 382-2000 Fax: (1) 414 382-4444